

ROBINAIR

REFRIGERANT RECOVERY SYSTEM



USER'S OPERATING MANUAL

25175B

ADVANCED TEST PRODUCTS, INC • Miramar, FL
Telephone: (954) 499-5400 • Fax: (954) 499-5454 • Toll Free: (800) 327-5060
www.RobinairHVAC.com



TABLE OF CONTENTS

IMPORTANT SAFETY INFORMATION	3
OPERATING GUIDELINES	4-5
CARE AND MAINTENANCE OF YOUR 25175B	5
ADDITIONAL RECOVERY TANK INFORMATION	6
PURGING NON-CONDENSABLE GASES	7
HELPFUL HINTS FOR REFRIGERANT RECOVERY	8-9
OPERATING YOUR 25175B	10
DIAGRAM FOR REFRIGERANT RECOVERY	10
SELF PURGING YOUR 25175B	11
SELF PURGE/AUTO EVACUATE	11
DIAGRAM FOR "PUSH/PULL" METHOD	12
SET-UP DIAGRAM FOR TANK PRE OR SUB COOLING PROCEDURE	12
OPTIONAL RECOVERY / TANK PRE OR SUB COOLING FOR FIXED HOSE SET-UP	13
REFRIGERANT FLOW DIAGRAM	14
25175B PARTS DIAGRAM/PARTS AND ACCESSORIES LIST	15
25175B AND 25175B-KT WIRING DIAGRAMS	16
INSTALLATION OF OPTIONAL 80% TANK CAPACITY SENSING COMPONENTS (KIT KT-5001)	17
25175B-KT MODEL	17
TROUBLESHOOTING YOUR 25175B	18
FULL ONE YEAR WARRANTY	19
ENVIRONMENTAL PROTECTION AGENCY (EPA) INSTRUCTIONS	20
EPA REGIONAL OFFICES	21

⚠ IMPORTANT SAFETY INFORMATION ⚠

SAFETY COMES FIRST! Read all safety, operating guidelines and instructions before operating your 25175B.

1. **CAUTION: ONLY A QUALIFIED TECHNICIAN SHOULD OPERATE THIS RECOVERY UNIT.**

The operator must be familiar with air conditioning and refrigeration systems, refrigerants and the dangers of pressurized components.

2. Always think before acting, familiarity breeds carelessness and carelessness can be harmful to your health or, worse, result in death.

3. ⚠ **WARNING** Always wear safety goggles and protective gloves when working with refrigerants. Contact with refrigerant may cause injury. Disconnect hoses with extreme caution! All hoses may contain liquid refrigerant under pressure.

4. ⚠ **PRESSURIZED TANK CONTAINS LIQUID REFRIGERANT. NEVER OVERFILL STORAGE TANKS. OVERFILLING OF THE TANK MAY CAUSE A VIOLENT EXPLOSION AND POSSIBLE INJURY OR DEATH. DO NOT:** Exceed the working pressure of Recovery Tank cylinder.

5. ⚠ **Warning: DO NOT:** Exceed the working pressure of each cylinder. Recovery cylinders are designed for different pressures. Your 25175B is not supplied with a recovery tank, it requires the use of tanks with a minimum of 350 psi working pressure and ROBINAIR strongly recommends the use of 400 psi tanks.

NOTE: The use of a **400 psi tank is mandatory** when recovering **R410A**.

See ROBINAIR Recovery Tanks under Parts and Accessories section on Page 15.

6. ⚠ A scale must be used to avoid overfilling the storage tank. **DO NOT OVERFILL.** Tank is full at 80% volume. Tank may explode if filled more than 80% due to liquid expansion.

7. Use **ONLY** authorized refillable refrigerant tanks. **NEVER** use a standard disposable 30lb. tank (the type of container in which virgin refrigerant is sold) to recover refrigerant.

8. Read all safety information regarding the safe handling of refrigerant and refrigerant oil, including the Material Safety Data Sheet. MSDS sheets can be obtained from your refrigerant supplier.

9. If you expect temperatures in excess of 135° F, contact the refrigerant supplier.

10. Be sure that any room where you are working is thoroughly ventilated, especially if a leak is suspected. Refrigerant vapor is hazardous to your health and can cause death.

11. ⚠ **Avoid breathing A/C refrigerant and lubrication vapor or mist.** Exposure may irritate eyes, nose and throat. If accidental system discharge occurs, ventilate work area before resuming service.

12. ⚠ **WARNING: TO REDUCE THE RISK OF FIRE:**

- Never operate unit in an explosive environment! Do not use this equipment in the vicinity of spilled or open containers of gasoline or any other flammable liquid.

- When using an extension cord it should be a 3-wire, 14 AWG minimum and no longer than 25 feet.

- Use this equipment in locations with mechanical ventilation that provides at least four air changes per hour or locate the equipment at least 18 inches above the floor.

- Never use oxygen when testing for leaks. Any oil in contact with oxygen under pressure will form an explosive mixture.

13. ⚠ **High voltage electricity inside panels. Risk of electrical shock.** Be sure to disconnect the unit from the power source before servicing it.

14. To reduce the risk of injury, care should be taken when moving this equipment.

OPERATING GUIDELINES

⚠ Before operating the 25175B recovery unit, read the following ⚠

1. 25175B IS APPROVED FOR USE WITH THE FOLLOWING CATEGORY III, IV and V REFRIGERANTS (Per ARI 740):

R-12, R-22, R-134A, R-401A, R-401B, R-401C, R-402A, R-402-B, R-404A, R-406A, R-407A, R-407-B, R-407C, R-407D, R-408A, R-409A, R-410A, R-411A, R-411B, R-412A, R-500, R-502, R-507 and R-509

2. A **FILTER** must **always** be used and should be replaced frequently. We recommend that a clean filter be used for every service job. Failure to use a filter will invalidate your warranty.

The use of a filter will greatly reduce the risk of damage to your 25175B, by preventing foreign material from entering the unit.

3. Each filter should be labeled and used exclusively for one type of refrigerant only.

4. Always open service and cylinder valves slowly. This allows rapid control of the flow of gases if there is any danger. Once it is determined that there is no danger, the valves can be opened fully.

5. Always isolate large amounts of refrigerant and close off valves after use, so if a leak should develop anywhere in the system, the refrigerant will not escape.

6. Keep all connections to the refrigeration system thoroughly dry and clean. If moisture enters the refrigeration system, it is likely to cause considerable damage.

7. Robinair strongly recommends the use of the **optional** 80% Capacity Shutoff Kit (p/n KT-5001). When installed and used with a recovery tank that has an internal float switch, the 25175B will shut down automatically when the tank is 80% full. Your 25175B is pre-wired from the factory for this kit.

Note: The 25175B is also available in model 25175B-KT, with the 80% Shutoff Kit installed direct from the factory.

8. ⚠ **CAUTION:** Use only authorized refillable refrigerant recovery tanks. Federal regulations require refrigerant to be transported only in containers meeting DOT spec. 4BA or 4BW. **NEVER** use a standard disposable 30lb. tank (the type of container in which virgin refrigerant is sold) to recover refrigerant.

9. ⚠ A scale must be used to avoid overfilling the storage tank. **DO NOT OVERFILL.** Tank is full at 80% volume. Tank may explode if filled more than 80% due to liquid expansion. Below is a representative sample for R-22 refrigerant:

TANK SIZE	MAX NET WEIGHT
30 lb. Tank	24 lbs.
50 lb. Tank	40 lbs.

Note: Robinair strongly recommends the use of the ADS-100 Refrigerant Scale for monitoring tank capacity.

10. Your 25175B has an Internal Pressure Shut Off Switch. If the pressure inside the system should go above 470 psi, the system will automatically shut itself off. The shutoff switch will automatically reset itself again after the pressure drops below 300 psi.

⚠ **WARNING:** The Internal Pressure Shut Off Switch does not prevent tank overfill. If your system shuts off on high pressure and is connected to your tank, you may have overfilled your tank and created a very dangerous situation! Take immediate measures to relieve any high pressure and/or tank overfill.

11. When recovering large amounts of liquid, use the "Push/Pull method (see diagram on page 11).

⚠ **CAUTION:** When using the "Push/Pull" method, once the "Push/Pull" siphon is started, it can continue and overfill the storage tank even if the tank is equipped with a "shut off" float sensor. The siphon can continue even after the machine is turned off. You must manually close the valves on the tank and the unit to prevent overfilling of the recovery tank.

12. Always operate the unit on a flat level surface

13. To achieve the deepest final vacuum, use the tank cooling method to lower the head pressure on the recovery tank. (See Pages 12 & 13). Repeat as necessary to achieve the desired vacuum level.

OPERATING GUIDELINES - cont.

NOTE: If there is no liquid in the recovery tank, then the cooling method will not work. In this case, use an empty tank that has been fully evacuated to achieve the final vacuum level required.

14. If the tank pressure exceeds 300 psi, use the tank cooling procedure to reduce the tank pressure. (See Pages 12 & 13)
15. To maximize recovery rates, use the shortest possible length of 3/8" or larger hose. A hose no longer than 3 feet is recommended.
16. For maximum throughput, always remove all unnecessary hose core depressors and the Schraeder valves from port connections.
17. Deformed rubber seals and core depressors in hoses and faulty or unnecessary Schraeder valves can restrict flow up to 90%.

CARE AND MAINTENANCE OF YOUR 25175B

1. USE of a filter/dryer at the inlet is mandatory. A filter/dryer must always be used between the recovery machine and the inlet hose.
2. Special care should be taken when recovering from a "burned-out" system. Use two high acid capacity filters, in series. (Alco type EK-162-F or Sporlan type C-162-F are recommended)When you have finished recovering from the system, flush your 25175B with a small amount of clean refrigerant and refrigerant oil to purge off any foreign substances left in the unit.
3. Always empty refrigerant from the 25175B into a storage tank; see Self-Purge/Auto Evacuate procedure on Page 11. Liquid refrigerant left in the 25175B's condenser may expand, causing damage to components.
4.  Warning! Whenever you perform any type of maintenance work on your 25175B, insure that it is disconnected from the power supply before you begin.
5. If the unit is to be stored or not used for any length of time, we recommend that it be completely evacuated of any residual refrigerant and purged with dry nitrogen.

ADDITIONAL RECOVERY TANK INFORMATION

⚠ Warning: Also read the information pertaining to recovery tanks, previously listed under Safety Information and Operating Guidelines.

1. CAUTION: NEVER use a standard disposable 30lb. tank (the type of container in which virgin refrigerant is sold) to recover refrigerant. Use ONLY authorized refillable refrigerant tanks. Federal regulations require refrigerant to be transported only in containers meeting DOT specs. 4BW or 4BA.

2. **⚠ Warning: DO NOT:** Exceed the working pressure of each cylinder. Recovery cylinders are designed for different pressures. Your 25175B is not supplied with a recovery tank, it requires the use of tanks with a minimum of 350 psi working pressure and ROBINAIR strongly recommends the use of 400 psi tanks.

NOTE: The use of a 400 psi tank is mandatory when recovering R-410A.

See ROBINAIR Recovery Tanks under Parts and Accessories section on Page 15.

3. Tanks and filters should be designated for one refrigerant only. Before using a tank previously

used for another refrigerant, completely empty the tank, evacuate it and purge the tank using dry nitrogen, and then re-evacuate it.

3. Always store refrigerant containers in a cool dry place.











5. Do not mix refrigerants in a system, a tank or any where else. Each type of refrigerant must have its own tank, filter, etc.

6. Storage cylinders sometimes have valves that are not properly seated when manufactured. Keeping caps on these valves will guard against refrigerant leakage.

7. Do not exceed 80% of tank capacity. ROBINAIR strongly recommends the use of the ADS-100 Refrigerant Scale for monitoring tank capacity. Safety codes recommend that closed tanks not be filled over 80% of volume with liquid. The remaining 20% is called head pressure room.

8. If you expect temperatures in excess of 135° F, contact the refrigerant supplier.

⚠ NEVER TRANSPORT AN OVERFILLED CYLINDER ⚠
Refrigerant expands when it gets warm and may cause a tank to explode if overfilled

CYLINDER TEMPERATURE	60°F	70°F	100°F	130°F	150°F
STARTING WITH CYLINDER 80% BY VOLUME					
SPACE OCCUPIED BY LIQUID	80%	81%	83%	90%	94%
STARTING WITH CYLINDER 90% BY VOLUME					
SPACE OCCUPIED BY LIQUID	90%	92%	96%	100%	

PURGING NON-CONDENSABLE GASES FROM REFRIGERANT TANK

1. Allow the tank to sit undisturbed for 24 hours. This allows the air to rise to the top.
2. Connect a manifold to the tank and read the amount of pressure in the tank by looking at the output pressure gauge.
3. Determine the ambient temperature in the room.
4. Refer to a Refrigerant pressure/temperature chart. Find the temperature on the chart and look across to the corresponding pressure for the type of refrigerant in the tank. Determine how that relates to the reading on the gauge.
5. If the pressure reading is higher than the pressure shown on the chart, very slowly (so as not to cause turbulence inside the tank) crack open the vapor port valve. Watch the pressure on the gauge decrease. To prevent venting, add 4-5 psi to the pressure shown on the chart. when the gauge corresponds to that pressure, close the vapor port valve.
6. Allow the tank to sit for 10 minutes and check the pressure again.
7. Repeat the process again if necessary.

HELPFUL HINTS FOR REFRIGERANT RECOVERY

Refrigerant recovery has come a long way in a few short years. On the surface it's simply the process of taking refrigerant out of a system and putting it into a tank. However, this simple process can quickly become problematic if a few items are overlooked. The following are some tips and pointers we've accumulated over the last few years that can save you time and make the process go smoother.

First you need to identify the refrigerant type and quantity in the system you are servicing. If you determine it's a burnout, you need a special tank (a tank that's identified as containing burnout or other unidentified gases), and you need to use extra filtration prior to recovery. (See item #2 on page 5)

If, on the other hand, you know the gas in the system is relatively clean or new, then a new tank should be used. If you're planning on putting the refrigerant back into the same system after you have finished the service or if the refrigerant is going to be reclaimed, then use a tank that has the same refrigerant in it. A word of caution about the Environmental Protection Agency (EPA): If you use a variety of refrigerant gasses in your service work - as evidenced by your refrigerant purchases - and you only own one tank, you are asking for trouble. You would be well advised to own at least one tank for every refrigerant type serviced, plus an extra for burnouts and other unknowns.

PLANNING AHEAD

Knowing the quantity of refrigerant is important for planning storage requirements, as well as planning for the actual recovery. For instance, any system with more than 5lbs. of refrigerant is likely to have areas where the liquid can get trapped.

The key to a quick recovery procedure is to get the liquid out first, and then get the remaining vapor out. However most systems are not "*recovery friendly*." That is they don't have access ports at their lowest points. If some units you're servicing are on maintenance contracts, you would save significant time by installing access ports at all of the lowest points in the system, where liquid is likely to accumulate.

Since most systems don't have these ports you need to be prepared to boil off the trapped liquid with a heat gun, when ever it's found. An indicator of trapped liquid in a system is frost or condensation forming on the plumbing or components where the liquid is trapped. The trapped liquid may be in an area that is not visible. In all cases trapped liquid in a system during recovery causes the recovery process to slow down, regardless of the size or type of machine (*see diagram*).

If you are unable to locate the trapped liquid, but you know it's there, because the recovery job is taking "*forever*". Turn on the system compressor (if it's operable) for a few seconds, this will get the refrigerant moving to another part of the system and in the process pick up enough heat to boil off.

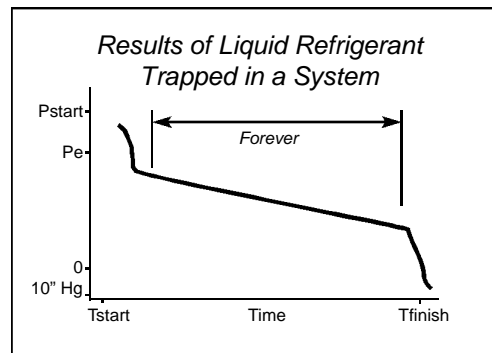

HOSES AND VALVES

Hoses and Schraeder valves have a large impact on recovery speed. In general, the larger the hose, the less friction on the flow of refrigerant, the quicker the recovery time. Many contractors are now using 3/8' lines for the input to the recovery machine, even those lines originating out of 1/4" fittings.

Schraeder valves must be removed from the connection prior to an expedient recovery. Most wholesalers sell a tool for removing these cores, while keeping the connection sealed. The core depressor, in the end of the hose, should also be removed. These two items can turn a 20 minute job into one that goes on for hours. So, be sure to remove the Schraeder valves and core depressors before every recovery job.

Another hose consideration is the little rubber grommet at the end of the hose that makes a seal with the flare fitting. We've seen these seals so worn and deformed that when the hose is connected to the flare fitting the grommet virtually seals off the connection.

HELPFUL HINTS FOR REFRIGERANT RECOVERY - cont.

This is probably never noticed in charging, because the pressure opens the grommet, but during recovery (or with suction) the deformed grommet severely restricts the flow of refrigerant.

REFRIGERANT RECYCLING

Current regulations state that used refrigerant shall not be sold, or used in a different owner's equipment, unless the refrigerant has been laboratory analyzed and found to meet the requirements of ARI 700 (latest edition). As a result, recycling and verifying ARI 700 conformance isn't economically justified in most cases. It's still a great idea to do as much cleaning of refrigerant going back into the same system (or owners system) as possible. We recommend using the largest, high-acid capacity filter, that are economically feasible. Put these filters on the suction or inlet side of the recovery unit. Change filters often.

The recovery of large amounts of liquid refrigerant can sometimes carry with it large quantities of oil, if the system being serviced doesn't have an adequate oil separator installed. If this recovered refrigerant isn't going to be liquid charged back into the same system, you might want to separate the refrigerant from the oil in order to measure the oil (to know how much oil to charge back into the system). Refrigerant sent back for reclaim does not need to have the oil removed. One of the simplest and most cost effective ways to achieve this is to use a 30 or 50 lb. tank in line with your recovery machine. Connect the system to the liquid port of the tank, then from the vapor port of the tank connect to the input of your recovery machine. A second tank, for storing refrigerant, should then be connected to the output of the recovery machine. If you encounter large amounts of liquid you will need to put a band heater around the first tank. When the recovery job is complete the oil can be removed, from the first tank, by applying a small amount of pressure, using nitrogen, to one of the ports and extracting the oil from the other. If you are going to remove the oil from the vapor port you will need to turn the tank upside down. Always wear safety glasses when performing this operation as the oil may be acidic and could cause severe burning.

KEEPING THE DIRT OUT

During the recovery process your recovery machine can be exposed to debris that can, potentially, damage it. This includes brazing spatter and copper/ brass slithers. Further contamination can be introduced from the refrigerant storage tanks. To prolong the life of your recovery machine, **always use an inline filter at the inlet Port.**

Whenever you are charging a system from a recovery cylinder it is a good idea to use an in-line filter to protect the system from contamination. Again, change your in-line filters often.

GETTING THE LIQUID OUT

See diagram on page 12 of this manual

Push/pull is a method of removing bulk liquid from a system using the pressure differential created by the recovery machine. Push-pull will generally not work on smaller systems because there is no bulk liquid reservoir to create a siphon from.

Push-pull is mostly used on systems with a receiver tank or those with greater than 20 lbs. of refrigerant, or when transferring from one tank to another. The rate of liquid transfer is very much dependent on hose size, with larger hoses providing much better throughput.

Another trick is to cool the tank, if it's partially filled, prior to or during recovery. This operation will lower the pressure in the storage tank and therefore speed up recovery. There must be a minimum of 5 lbs of liquid refrigerant in the tank you wish to chill. This operation can be performed prior to or during the recovery. See the two set up diagrams and procedures on page 12-13 of this manual.

There is nothing magic here, you are simply using your recovery machine to make a refrigerator where the tank is the evaporator. By throttling the output valve, you're effectively creating a capillary tube or an expansion device, but you need to adjust the back pressure to suit the conditions and the refrigerant. Five to ten minutes of chilling can produce some very dramatic tank cooling, depending on the conditions. If there are any non condensables in the tank this process will not work. The greater the quantity of refrigerant in the tank the longer the process will take.

OPERATING YOUR 25175B

PROCEDURE FOR NORMAL SYSTEM RECOVERY

1. Inspect the 25175B thoroughly to insure that it is in good operating condition.
2. Make sure all connections are correct and tight (see set-up diagram below).
3. Open the liquid port of the recovery cylinder (always open valves slowly to check hoses and connections for leaks).
4. Make sure the Recover/Purge valve is set on Recover.
5. Open the output port of the 25175B
6. Open the liquid port on your manifold gauge set; opening the liquid port will remove the liquid from the system first, greatly reducing the recovery time. (after the liquid has been removed, open the manifold vapor port to finish evacuating the system).
7. Connect your 25175B to a 115V outlet.
 - a. Switch the main power switch to the ON position. You should hear the fan running.
 - b. Press the compressor start switch. This "momentary" switch will start the compressor.
8. Slowly open the input port on the 25175B.
 - a. If the compressor starts to knock, slowly throttle back the input valve until the knocking stops.
 - b. If the input valve was throttled back, it should be fully opened once the liquid has been removed from the system (the manifold gauge set vapor port should also be opened at this time).
9. Run until desired vacuum is achieved.
 - a. Close the manifold gauge sets vapor and liquid ports.
 - b. Close the 25175B input port.
 - c. Shut off and proceed with the Self Purge procedure on the next page.

It may be necessary, under certain circumstances, to press this switch more than once to start the compressor.

Note: Always purge the 25175B after each use (see Self Purge procedure on page 11). Failure to purge the remaining refrigerant from the 25175B could result in the acidic degradation of internal components, ultimately causing premature failure of the unit.

DIAGRAM FOR REFRIGERATION RECOVERY

THIS IS THE FASTEST METHOD FOR RECOVERING VAPOR REFRIGERANT

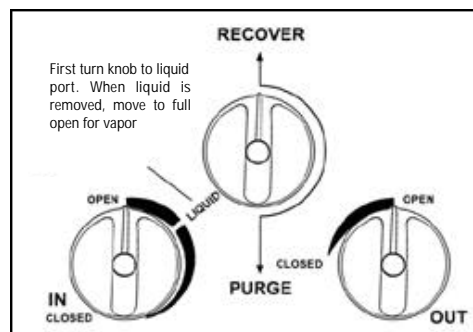
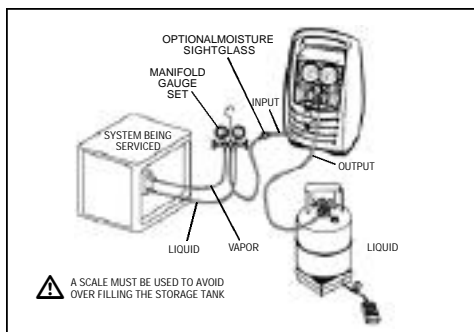

SELF PURGING YOUR 25175B

PROCEDURE FOR PURGING REMAINING REFRIGERANT FROM THE 25175B

1. Close the ports of the system being serviced that are connected to the input port of the 25175B.
2. Close the input port on the 25175B.
3. Turn off the 25175B.
4. Turn the Recover/Purge valve to the Purge position.
5. Restart the 25175B.
6. Run until desired vacuum is achieved.
7. Close the ports on the recovery tank and the 25175B.
8. Turn the 25175B off.
9. Return the Recover/Purge valve to the Recover position.
10. Disconnect and store all hoses.
11. Replace the in-line filter on your 25175B after every job.

SELF PURGE/ AUTO EVACUATE

To change from Recovery mode to Purge follow the steps below:

1. Close the Input port
2. Turn the unit off (to prevent high pressure shutoff).
3. Switch to Purge position.
4. Restart the unit.

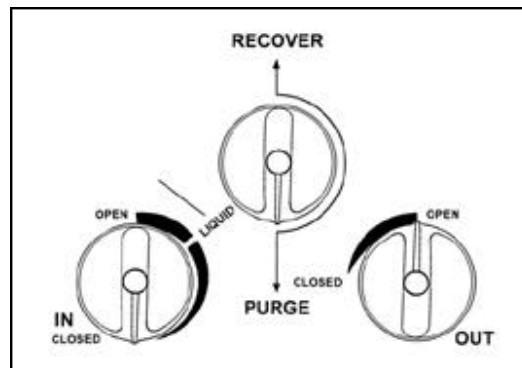

DIAGRAM FOR "PUSH/PULL" METHOD

Push/pull method only works with large systems where the liquid is readily accessible. Do not use this method on systems that contain less than 15 lbs. as it may not work.

The sight glass is used to provide a method of determining the moisture content and quality of a system's refrigerant.

⚠ CAUTION: When using the "Push/Pull" method, once the siphon is started, it can continue and overflow the storage tank even if the tank is equipped with a float level sensor. The siphon can continue even when the machine is turned off. You must manually close the valves on the tank and the unit to prevent overflowing of the recovery tank.

1. Put RECOVER/PURGE knob on RECOVER.
2. Open OUTPUT valve.
3. Open INPUT valve
4. When the scale stops rising close all ports.
5. Switch off the machine

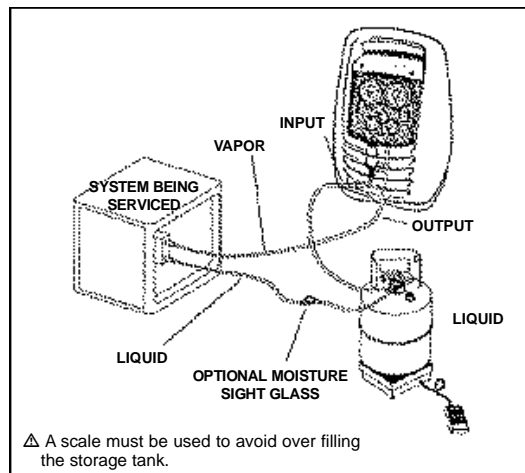

SET-UP DIAGRAM FOR TANK PRE OR SUB COOLING PROCEDURE

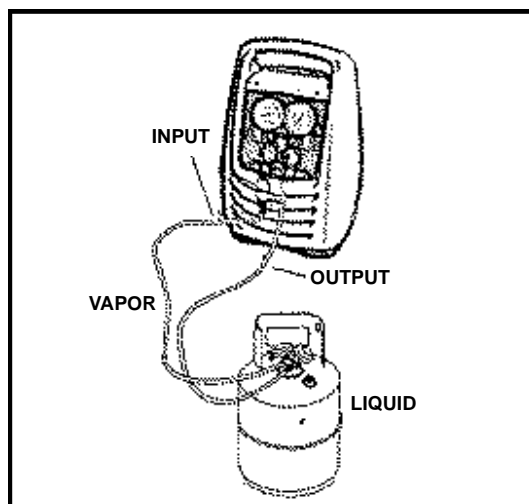

See page 9 of this manual for more information.

1. To start you must have a minimum of 5 lbs. of liquid refrigerant in the tank.
2. Put RECOVER/PURGE knob on RECOVER.
3. Start machine.
4. Open INPUT valve to liquid.
5. Throttle the output valve so that the output pressure is 100 psi greater than the input pressure, but never more than 300psi.
6. Run until tank is cold.

OPTIONAL RECOVERY/TANK PRE OR SUB COOLING FOR FIXED HOSE SET-UP

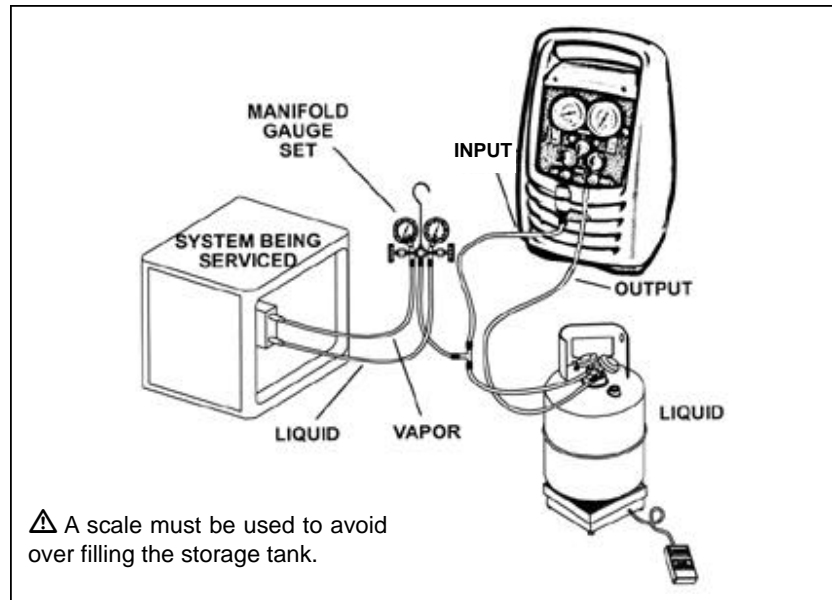

NORMAL RECOVERY:

Tank Vapor valve is closed

TANK PRE OR SUB COOLING:

Tank Vapor valve is open and both manifold gauge set valves are closed.

REFRIGERANT FLOW DIAGRAM

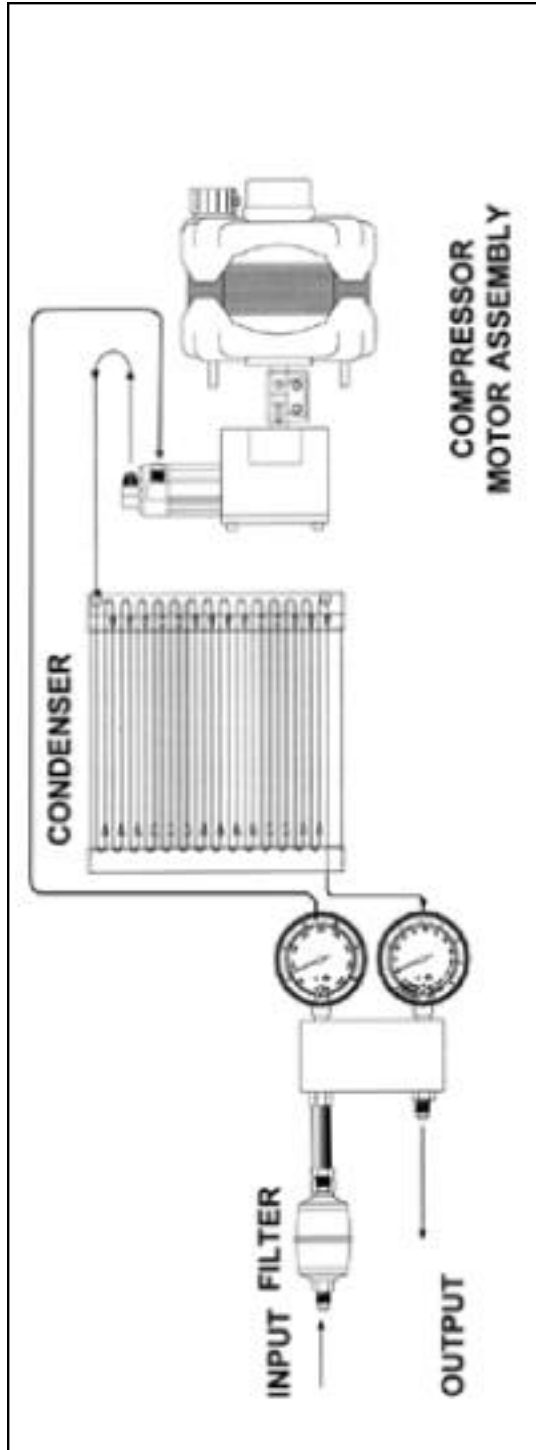

NOTE: A filter must always be used. Failure to use a filter will invalidate your warranty.

The use of a filter will greatly reduce the risk of damage to your **25175B** by preventing foreign material from entering the unit.

Special consideration for filtration must be given when you know you are servicing a machine that has "Burned Out." We recommend the use of two size 162 filter driers, in line, to be used for that job and that job only.

25175B PARTS DIAGRAM

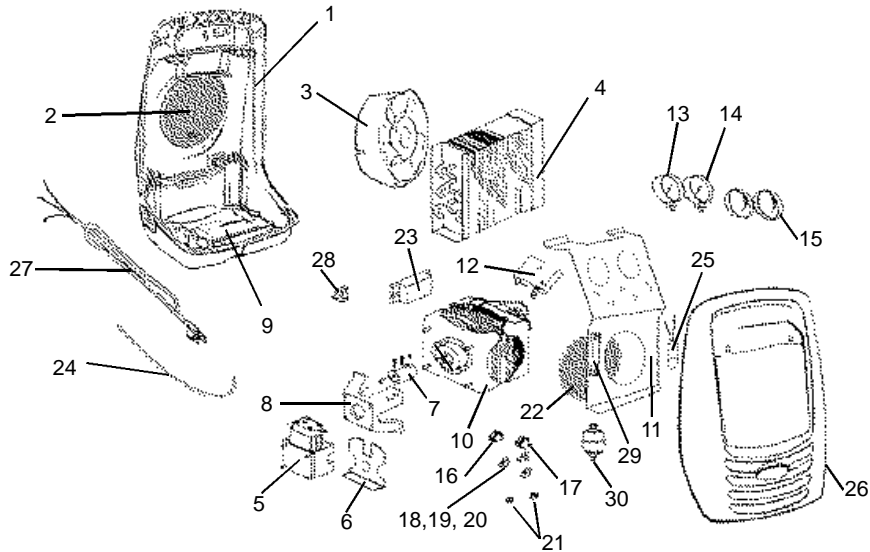

25175B PARTS LIST

ITEM DESCRIPTION	PART#	11 FRONT PANEL	(100383)	22 GRILLE INLET	(SH5022)
1 REAR COVER	(R121839)	12 MANIFOLD	(700150)	23 *RELAY	(EL1500)
2 FAN GRILL, OUTLET	(R122276)	13 INPUT GAUGE	(GA1500)	24 *SENSOR CORD	(EL1420)
3 FAN	(EL1817)	14 OUTPUT GAUGE	(GA0800)	25 CAPACITOR	(EL1412)
4 CONDENSER	(100478)	15 GAUGE LENS	(GA1000)	26 FRONT COVER	(R121838)
5 COMPRESSOR	(CP1320)	16 ON/OFF SWITCH	(EL1310)	27 CORD SET	(R111443)
6 COMPRESSOR BRACKET	(100207)	17 START SWITCH	(EL1309)	28 PRESSURE SWITCH	(100535)
7 COUPLER	(CP1315)	18 RED KNOB	(100124)	29 HOSEASSY	(100345)
8 BELL HOUSING	(CP1001)	19 BLACK KNOB	(100122)	30 FILTER	(100343)
9 MOTOR BRACKET	(100528)	20 BLUE KNOB	(100123)		
10 MOTOR	(EL1821)	21 FLARE CAP (2)	(NB6501)		

*OPTIONAL COMPONENTS FOR 80% CAPACITY TANK SENSING KIT

REPLACEMENT KITS & ACCESSORIES

PART#	DESCRIPTION
KT3302	PISTON SEAL REPLACEMENT (middle section of compressor)
KT3303	VALVE REPLACEMENT KIT (top section of compressor)
KT3307	COMPRESSOR REPAIR KIT (all three sections of compressor)
KT3308	SHAFT REPLACEMENT KIT (bottom section of compressor)
KT5001	80% CAPACITY TANK SENSING KIT
RGT30	30 LB RECOVERY TANK (350 psi working pressure) with capacity sensor
RGT30NS	SAME AS RGT30, WITHOUT SENSOR
RGT50	50 LB RECOVERY TANK (350 psi working pressure) with capacity sensor
RGT50NS	SAME AS RGT50, WITHOUT SENSOR
RGT50HP	50 LB RECOVERY TANK, HIGH PRESSURE(400 psi working pressure) with capacity sensor
ADS-100	REFRIGERANT SCALE, 200LB CAPACITY, WITH REMOVABLE PLATFORM

25175B WIRING DIAGRAM

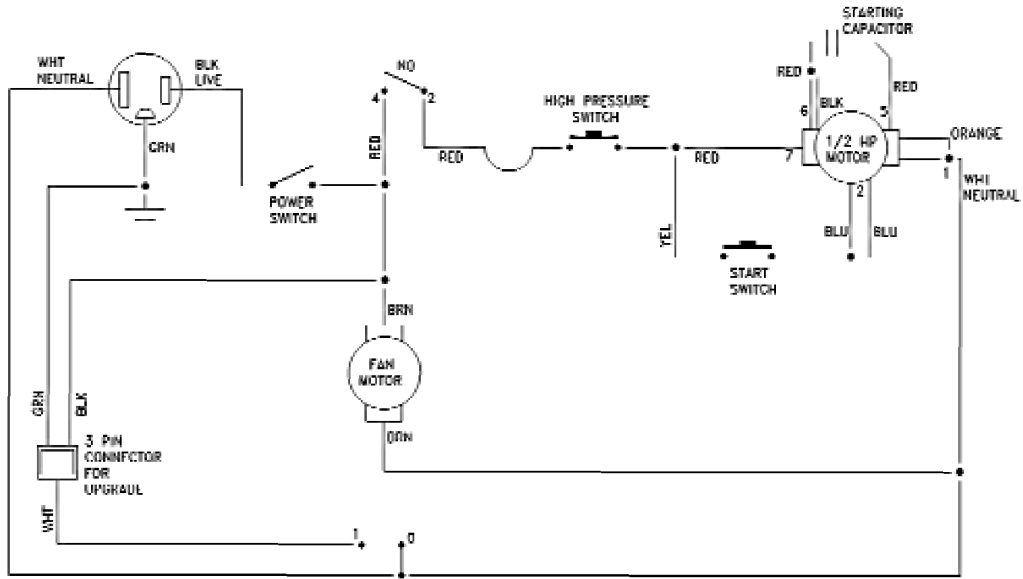

25175B-KT WIRING DIAGRAM

INCLUDING OPTIONAL TANK CAPACITY SENSING CIRCUITRY (KIT:KT5001)

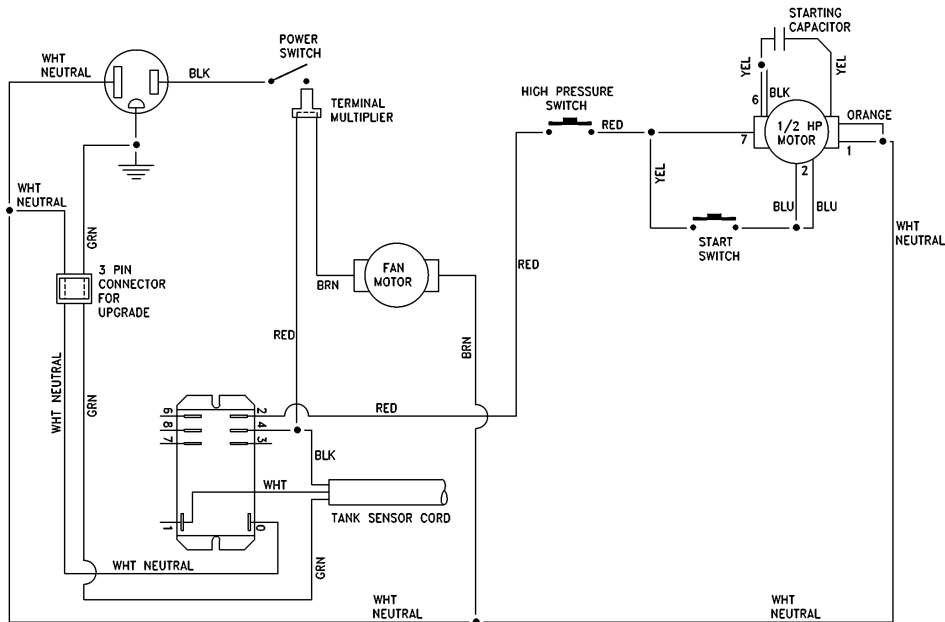

INSTALLATION OF OPTIONAL 80% TANK CAPACITY SENSING COMPONENTS (KIT:KT5001)

Note: ROBINAIR also offers the model, 25175B-KT, with the 80% Capacity Shut Off Kit installed at the factory.

⚠ Warning: Prior to performing any type of maintenance work on your 25175B, insure that it is disconnected from the power supply before you begin.

NOTE: Refer to the wiring diagram at the bottom of page 16 during installation of your kit.

1. Disconnect your 25175B from the power source
2. Remove the fasteners from each side of the 25175B and separate both halves of the plastic case.
Note: You may find it more convenient to disconnect the two wires to the fan, if so remember to reconnect them prior to re-installing the case.
3. Place the metal frame of the 25175B in the upright position
4. Remove the "pry out plug" from the hole located at the lower right of the front panel, and pass the tank sensor cord (p/n EL1420) through it.
5. Visually identify the two studs located on the left side of the front panel. (this will be the location for the relay, p/n EL1500, after all your electrical connections are made.)
6. Disconnect a red wire from the high-pressure switch (located under the start switch) Note: There are two red wires on the high-pressure switch, disconnect the one that originates from the Power Switch.
7. Ensure that the terminal multiplier (p/n EL1221) is placed on terminal #4 of the relay and then place the red wire removed from the high pressure switch on that terminal.
8. Place the black wire from the sensor cord on the other side of the terminal multiplier, on the same terminal #4 of the relay.
9. Place the white wire from the sensor cord on terminal #0 of the relay.

10. Connect the white wire from the male side of the 3 pin connector (p/n EL1215) to terminal #1 of the relay.

Note: Ensure that the green wire from the sensor cord is connected to the center of the 3-pin connector. (Note: only two wires are used in this connector).

11. Connect the 3-pin connector to its female counterpart, already pre wired on your 25175B.

Note: make sure the two wires, (1) green and (1) white, are in the proper position (directly across) from their mating wires.

12. Connect one end of the red wire (p/n WR1403), supplied with your kit, to terminal #2 of the relay and the other end to the high pressure switch.
13. Secure the relay onto the two studs mentioned in Step 5, using the hardware already installed on the studs.
14. Secure the tank sensor into the hole in the front panel with the strain relief grommet provided.
15. Replace the fan wires, if removed in step # 2.
16. Secure any loose wiring with the wire ties provided.
17. Replace the plastic case halves and fasteners.
18. Test the installation by momentarily attempting to start the 25175B without the sensor cord connected to a tank sensor. The unit's compressor should not start up. Turn the 25175B off and re-attempt to start the unit with the sensor cord connected to a tank with a tank capacity sensor. The unit should function normally. Disconnecting the sensor cord while the unit is running should cause the unit to shut down.
19. If your unit does not function per above, **DISCONNECT** the 25175B from the **Power Supply**, and re-check your connections per the above steps and the wiring diagram at the bottom of page 16.

25175B-KT MODEL

ROBINAIR offers the model, 25175B-KT, with the 80% Capacity Shut Off Kit (p/n KT-5001) installed at the factory. On this model, when used with a recovery tank that has an internal float switch, the recovery unit will automatically shut off when the recovery tank is 80% full.

TROUBLESHOOTING YOUR 25175B

SAFETY FIRST

Read and understand all safety information contained in this manual before servicing the unit.

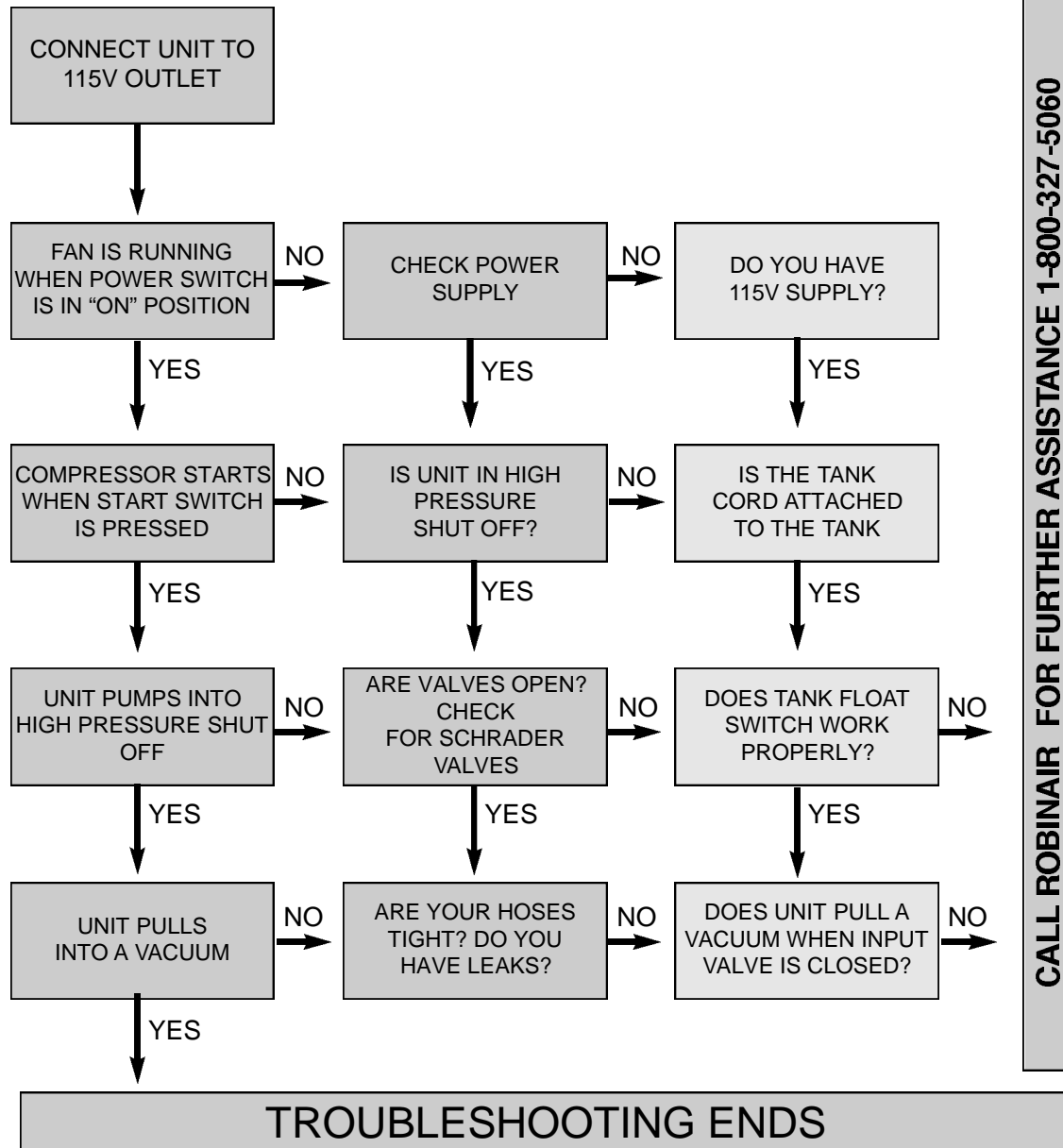

CALL ROBINAIR FOR FURTHER ASSISTANCE 1-800-327-5060

FULL ONE YEAR WARRANTY

MFG # _____

Robinair products are warranted to be free from defects in workmanship and materials for a period of one year from date of purchase.

THE FOLLOWING RESTRICTIONS APPLY:

1. The warranty applies to products in normal use only, as described in the operating manual. The product must also be serviced and maintained as described therein.
2. If the product fails, it will be replaced at the option of Advanced Test Products, Inc. (ATP)
3. Warranty service claims are subject to factory inspection for product defect(s). If during the warranty evaluation it is determined that a filter has not been used or that the filter was not properly maintained or that the machine has been used in any way other than the purpose for which it was designed, ATP, reserves the right to void the warranty.
4. All warranty claims must be made within the warranty period. Proof of purchase must be supplied . This warranty is non-transferable.
5. Please note that the warranty does not apply if the product or product part is damaged by accident, misuse, tampered with or modified in any way.
6. Normal wear items (seals, filters, etc.) are specifically excluded from warranty, unless found by Robinair to be defective.

WARRANTY SERVICE

This warranty is given by ADVANCED TEST PRODUCTS, INC.
Service under this warranty must be obtained by the following steps:

1. Outside the U.S.A. contact your local Robinair Distributor.
2. Inside the U.S.A. call 1.800.327.5060 or 954-499-5400 for a return material authorization (RMA) number.

THE UNITED STATES ENVIRONMENTAL PROTECTION AGENCY (EPA) REFRIGERANT RECOVERY AND RECYCLING DEVICE ACQUISITION CERTIFICATION FORM

EPA regulations have required establishments that service or dispose of refrigerant or air conditioning equipment to certify that they have acquired recovery and recycling devices that meet the EPA standards for such devices since August 12, 1993. To certify that you have acquired equipment, please complete this form according to the instructions and mail it to the appropriate EPA Regional Office. BOTH THE INSTRUCTIONS AND MAILING ADDRESS CAN BE FOUND ON THE NEXT PAGE OF THIS MANUAL.

Part 1: ESTABLISHMENT INFORMATION

UNIT STORAGE ADDRESS

<i>Name of Establishment</i>	<i>Name of Establishment</i>
<i>Street</i>	<i>Street</i>
<i>City</i> <i>State</i> <i>County</i>	<i>City</i> <i>State</i> <i>County</i>
<i>Zip Code</i> <i>(Area Code)</i> <i>Telephone Number</i>	<i>Zip Code</i> <i>(Area Code)</i> <i>Telephone Number</i>

NUMBER OF SERVICE VEHICLES BASED AT ESTABLISHMENT

Part 2: REGULATORY CLASSIFICATION

Identify the type of work performed at your establishment. Check all boxes that apply.

- Type A - Service small appliances.
- Type B - Service refrigeration or air conditioning equipment other than small appliances.
- Type C - Dispose of small appliances
- Type D - Dispose of refrigeration or air conditioning equipment other than small appliances.

Part 3: DEVICE IDENTIFICATION

<i>Name of Device Manufacturer</i>	<i>Model #</i>	<i>Month/Year</i>	<i>Mfg# (if any)</i>	<i>Self Contained</i>

Part 4: SIGNATURE

I certify that the establishment named in part 1. has acquired the refrigerant recovery or recycling devices listed in part 3. and that this equipment will be properly used in service (and/or) disposing of appliances. I also certify that the information supplied herein is correct and true.

Signature of owner / Responsible Officer	Date	Name (please print)	Title
--	------	---------------------	-------

Public reporting burden for this collection of information is estimated to vary from 20-60 minutes per response with an average of 40 minutes per response including time for reviewing instructions, searching existing data sources, gathering and maintaining the data needed and completing the collection of information. Send comments regarding the burden estimate or any other aspect of this collection of information, including suggestions for reducing the burden to: Chief information Policy Branch EPA, 401 M St. S.W. (PM223Y), Washington, DC 20460 and to the Office of information and Regulatory Affairs, Office of Management and Budget, Washington, DC 20503 marked Attention, Desk Officer for EPA.

DO NOT SEND THIS FORM TO THE ABOVE ADDRESSES. ONLY SEND COMMENTS TO THESE ADDRESSES

INSTRUCTIONS

EPA REGIONAL OFFICES

Part 1. Please provide the name, address and telephone number of the establishment where the refrigerant recovery or recycling device(s) is (are) located. Please complete one form for each location. State the number of vehicles based at this location that are used to transport technicians and equipment to and from service sites.

Part 2. Check the appropriate box for the type of work performed by technicians who are employees of the establishment. The term "small appliance" refers to any of the following products that are fully manufactured, charged and hermetically sealed in a factory with five or less pounds of refrigerant:

Refrigerators or freezers designed for home use, room air conditioners (including window air conditioners and packaged thermal air conditioners), packaged thermal heat pumps, dehumidifiers, under-the-counter ice makers, vending machines and drinking water coolers.

Part 3. For each recovery or recycling device acquired, please list the name of the manufacturer of the device and (if applicable) its model number and manufacturer number. If more than 8 devices have been acquired please fill out an additional form and attach it to the first one.

Recovery devices that are self-contained should be listed first and should be identified by checking the box in the last column on the right. A self-contained device is one that uses its own pump or compressor to remove refrigerant from refrigeration or air conditioning equipment. On the other hand, system dependent recovery devices rely solely upon the compressor in the refrigeration or air conditioning equipment and/or upon the pressure of the refrigerant inside the equipment to remove the refrigerant.

If the establishment has been listed as Type B and/or Type D in Part 2, then the first device listed in Part 3 must be a self-contained device and identified as such by checking the box in the last column on the right.

If any of the devices are homemade, they should be identified by writing "homemade" in the column provided for listing the name of the device manufacturer. Homemade devices can be certified for establishments that are listed as Type A or Type B in Part 2 until (six months after promulgation of the rule). If a Type C or Type D establishment is certifying equipment after (six months after promulgation of the rule), then it must not use these devices for service jobs classified as Type A or Type B.

Part 4. This form must be signed by either the owner of the establishment or another responsible officer. The person who signs is certifying that the establishment has acquired the equipment, that the establishment is complying with Section 608 regulations and that the information provided is true and correct.

Send your form to the EPA office listed under the state or territory in which your establishment is located.

CONNECTICUT, MAINE, MASSACHUSETTS, NEW HAMPSHIRE, RHODE ISLAND, VERMONT

CAA608 Enforcement Contact: EPA Region 1.
Mail Code APC, One Congress Street, John F. Kennedy Federal Building, Boston, MA02203-0001
Phone: (617) 565-3420

NEW YORK, NEW JERSEY, PUERTO RICO, VIRGIN ISLANDS

CAA 608 Enforcement Contact: EPA Region 2.
290 Broadway, New York, NY 10007-1866
Phone: (212) 637-3000

DELAWARE, DISTRICT OF COLOMBIA, MARYLAND, PENNSYLVANIA, VIRGINIA, WEST VIRGINIA

CAA608Enforcement Contact: EPA Region 3. Mail Code 3AT21, 1650 Arch Street, Philadelphia, PA 19103-2029
Phone: (215) 566-5000

ALABAMA, FLORIDA, GEORGIA, KENTUCKY, MISSISSIPPI, NORTH CAROLINA, SOUTH CAROLINA, TENNESSEE

CAA608 Enforcement Contact: EPA Region 4. Mail Code APT-AE, 100 Alabama Street, SW, Atlanta, GA 30303
Phone: (404) 562-8357

ILLINOIS, INDIANA, MICHIGAN, MINNESOTA, OHIO, WISCONSIN

CAA608 Enforcement Contact: EPA Region 5. Mail Code AT18J, 77 West Jackson Blvd., Chicago, IL 60604-3507
Phone: (312) 353-2000

ARKANSAS, LOUISIANA, NEW MEXICO, OKLAHOMA, TEXAS

CAA608 Enforcement Contact: EPA Region 6. Mail Code 6T-EC, Fountain Place, 12th Floor, Suite 1200
1445 Ross Avenue, Dallas, TX 75202-2733
Phone: (214) 665-6444

IOWA, KANSAS, MISSOURI, NEBRASKA

CAA608 Enforcement Contact: EPA Region 7. Mail Code ARTX/ARBR, 901 N. 5th Street, Kansas City, KS 66101
Phone: (800) 223-0425

COLORADO, MONTANA, NORTH DAKOTA, SOUTH DAKOTA, UTAH, WYOMING

CAA608Enforcement Contact: EPA Region 8. Mail Code 8AT-AP, 999 18th Street, Suite 500
Denver, CO 80202-2466
Phone: (303) 312-6312

AMERICA SAMOA, ARIZONA, CALIFORNIA, GUAM, HAWAII, NEVADA

CAA608 Enforcement Contact: EPA Region 9. Mail Code A-3, 75 Hawthorne Street, San Francisco, CA94105
Phone: (415) 744-1305

ALASKA, IDAHO, OREGON, WASHINGTON

CAA608Enforcement contact: EPA Region 10.
Mail Code AT-082, 1200 Sixth Ave.
Seattle, WA 98101
Phone: (206) 553-1200

SPX **ROBINAIR**



Miramar, FL
Phone: 954-499-5454
Toll Free; 1-800-327-5060
Fax: 954-499-5454
www.RobinairHVAC.com