

Recovery/ Recycling/ Recharging Unit

Operating Manual
Manual de Operación
Manuel d'utilisation

Model 17800B/17801B

Recovery/Recycling/Recharging Unit
for Multiple Refrigerants1

Modelo 17800B/17801B

Unidad de recuperación/reciclado/recarga
para múltiples refrigerantes49

Modèle 17800B/17801B

Poste de récupération/recyclage/
Recharge pour frigorigènes multiples..... 99

SAFETY DEFINITIONS: Follow all **WARNING**, **CAUTION**, and **NOTE** messages in this manual. These messages are defined as follows: **WARNING** means you may risk serious personal injury or death; **CAUTION** means you may risk personal injury, property damage, or unit damage; and **NOTES** and **OPERATING TIPS** provide clarity and helpful information. These safety messages cover situations ROBINAIR is aware of. ROBINAIR cannot know, evaluate, and advise you as to all possible hazards. You must verify that conditions and procedures do not jeopardize your personal safety.

DISCLAIMER: Information, illustrations, and specifications contained in this manual are based on the latest information available at the time of publication. The right is reserved to make changes at any time without obligation to notify any person or organization of such revisions or changes. Further, ROBINAIR shall not be liable for errors contained herein or for incidental or consequential damages (including lost profits) in connection with the furnishing, performance, or use of this material. If necessary, obtain additional health and safety information from the appropriate government agencies and the vehicle, refrigerant, and lubricant manufacturers.

WARNINGS



ALLOW ONLY QUALIFIED PERSONNEL TO OPERATE THE UNIT. Before operating the unit, read and follow the instructions and warnings in this manual. The operator must be familiar with air conditioning and refrigeration systems, refrigerants, and the dangers of pressurized components. If the operator cannot read this manual, operating instructions and safety precautions must be read and discussed in the operator's native language.



PRESSURIZED TANK CONTAINS LIQUID REFRIGERANT. Do not overfill the internal storage vessel, because overfilling may cause explosion and personal injury or death. Do not recover refrigerants into nonrefillable containers; use only federally authorized refillable containers (DOT spec. 4BW or 4BA).



HOSES MAY CONTAIN LIQUID REFRIGERANT UNDER PRESSURE. Contact with refrigerant may cause personal injury. Wear protective equipment, including safety goggles. Disconnect hoses using extreme caution.



AVOID BREATHING A/C REFRIGERANT AND LUBRICANT VAPOR OR MIST. Exposure may irritate eyes, nose, and throat. To remove refrigerant from the A/C system, use only equipment certified for the type of refrigerant being removed. Use the unit in locations with mechanical ventilation that provides at least four air changes per hour. If accidental system discharge occurs, ventilate the work area before resuming service.



DO NOT USE AN EXTENSION CORD. An extension cord may overheat and cause fire. If you must use an extension cord, use the shortest possible cord with a minimum size of 14 AWG.

TO REDUCE THE RISK OF FIRE, do not use the unit in the vicinity of spilled or open containers of gasoline or other flammable substances.



CAUTION—DO NOT PRESSURE TEST OR LEAK TEST EQUIPMENT AND / OR VEHICLE AIR CONDITIONING SYSTEMS WITH COMPRESSED AIR. Some mixtures of air and refrigerant have been shown to be combustible at elevated pressures. These mixtures, if ignited, may cause injury or property damage.



TO PREVENT CROSS-CONTAMINATION, USE THIS UNIT WITH R-134a REFRIGERANT ONLY. The unit is designed to recover, recycle, and recharge only R-134a refrigerant. Do not attempt to adapt the unit for another refrigerant. Do not mix refrigerant types through a system or in the same container; mixing of refrigerants will cause severe damage to the unit and the vehicle air conditioning system.



HIGH VOLTAGE ELECTRICITY INSIDE THE UNIT HAS A RISK OF ELECTRICAL SHOCK. Exposure may cause personal injury. Disconnect the power before servicing the unit.

Additional health and safety information may be obtained from the refrigerant and lubricant manufacturers.

OPERATING NOTE: At temperatures exceeding 120° F / 49° C, wait 10 minutes between recovery jobs.

This manual contains important safety procedures concerning the operation, use, and maintenance of this product. Failure to follow the instructions contained in this manual may result in serious injury. If you are unable to understand any of the contents of this manual, bring it to the attention of your supervisor. Do not operate this equipment unless you have read and understood the contents of this manual.

TABLE OF CONTENTS

Introduction.....	2
Glossary of Terms	2
General Operating Guidelines	3
Set Up Instructions.....	4
Operating Instructions.....	10
Recovery Procedures	10
Changing Refrigerant Types	12
A/C-R System Evacuation	14
Recycling Procedures.....	15
Charging Procedures	16
Correcting An Incomplete Transfer	17
Adding Refrigerant to the Tank	18
Operating Overview.....	20
Maintenance Procedures	23
Changing the Vacuum Pump Oil	23
Changing the Filter-Drier	24
Confirming the Scale Checklist	26
Correct Weight Verification.....	26
Calibrating the Scale.....	27
Calibrating the UL Circuit	28
Checking for Leaks	30
Changing the Temperature Scale	30
Operation Guidelines	31
Using the Control Panel	31
Keypad Functions	32
Using the Digital Display	32
Using the Diagnostic Mode	35
Using Display Codes	37
Replacement Parts	39
Flow Diagram	40
Wiring Diagram	41
Troubleshooting	43
Limited Warranty	47

See the Index on page 48 for a listing of all procedures and diagrams.

The 17800B/17801B is a complete A/C-R service center. It recovers, recycles, and recharges a wide range of refrigerants — from existing refrigerants to new substitutes and blends. With its multi-refrigerant capabilities, it is ideal for trucks, buses, and refrigerated trailers, as well as in-plant maintenance and other accessible installations.

The built-in manifold means the entire service procedure can be done with just one hook-up. A microprocessor controls the unit's functions; evacuation time and the amount of refrigerant to be recharged can be programmed at the beginning of the job. Prompts lead you through programming and alert you when the filter and vacuum pump oil need to be changed.

This unit is UL-listed and meets the SAE specifications for recycled refrigerant. It is also designed to be compatible with existing service equipment and standard service procedures.

This unit is simple to operate and has many user-friendly features:

- a built-in 6 cfm vacuum pump for quick, yet thorough, evacuation.
- a plastic enclosure for safe and easy maneuvering around vehicles without the worry of scratches.
- an electronic scale that weighs recovered refrigerant and recharges by weight for greatest accuracy.
- a pressure/temperature chart mounted directly above the gauges — with just a quick glance you can tell the temperatures in the system.
- large diameter wheels that make it easy to move the unit.

NOTE: To validate your warranty, complete the warranty card attached to your unit, and return it within ten days from date of purchase.

GLOSSARY OF TERMS

A/C-R	Air conditioning or refrigeration
A/C-R System	The air conditioning or refrigeration system serviced
Unit	The refrigerant recovery, recycling, recharging unit
Tank	The refillable refrigerant tank

GENERAL OPERATING GUIDELINES

- The voltage at the unit must be $\pm 10\%$ of the unit's rated voltage. Extension cords must be a minimum of 14 AWG and kept as short as possible.
- To interrupt any procedure (other than clearing), press **HOLD/CONT**. Press **HOLD/CONT** again to resume operation.
- System oil should be drained at the end of every recovery or recycling procedure, during the clearing process, or whenever oil is visible in the sight glass.
- The indicator light will tell you the state of the refrigerant coming into the unit during recovery: **ON** is liquid, **OFF** is vapor. The light is not used for recycling, since the refrigerant coming from the tank will always be a liquid.
- Some tanks have slightly different valve configurations. Connect the red hose to the GAS (vapor) valve; connect the blue hose to the LIQUID valve.
- To ensure scale readings are as accurate as possible, before each procedure, verify the tank is not touching the sides of the cart.
- To minimize mixing of refrigerants, follow the steps in *Changing Refrigerant Types* when switching between refrigerant types.
- When the unit is first turned on, the display shows either: "134a" (indicates R-134a automotive refrigerant using $\frac{1}{2}$ " Acme fittings); "R12" (indicates all other refrigerant types using $\frac{1}{4}$ " flare fittings); or "DOOR" (indicates the unit has been cleared).
Select R-12 or R-134a, and verify you have selected the correct refrigerant type.
- Use the correct hose set for the refrigerant type selected:

Hose Set	Tank Hoses (3)	System Hoses (2)
R-134a automotive	36", $\frac{1}{2}$ " Acme with double Quick Seal	96", one Quick Seal with one quick coupler
R-12 automotive	36", $\frac{1}{4}$ " flare with double Quick Seal	96", $\frac{1}{4}$ " flare with double Quick Seal
All other refrigerant types	36", $\frac{1}{4}$ " flare with single Quick Seal	96", $\frac{1}{4}$ " flare with ball valve

Setup Instructions

Before you begin any procedure, familiarize yourself with the components of the unit.

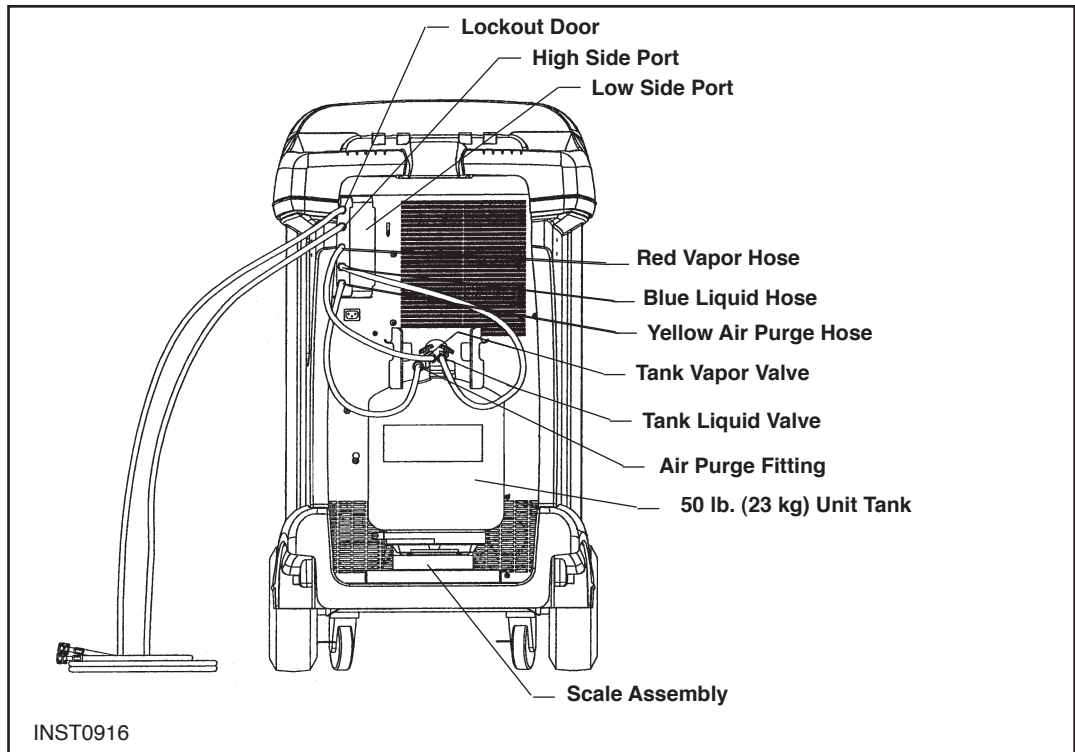

Diagram of Unit's Components — External View

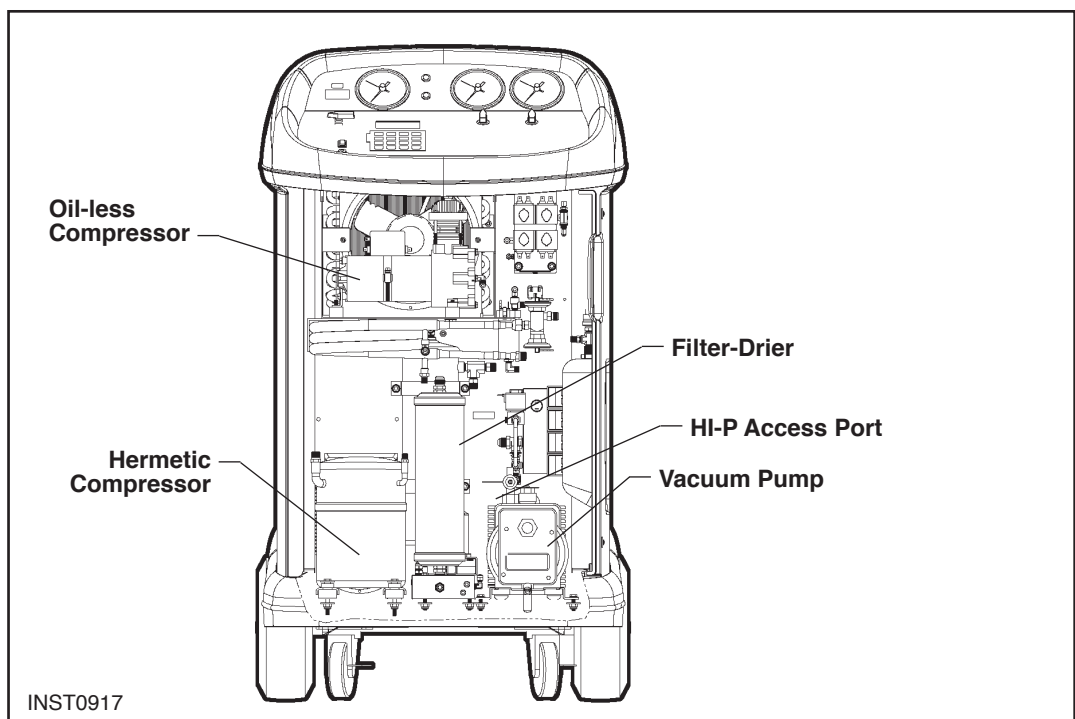

Diagram of Unit's Components — Internal View

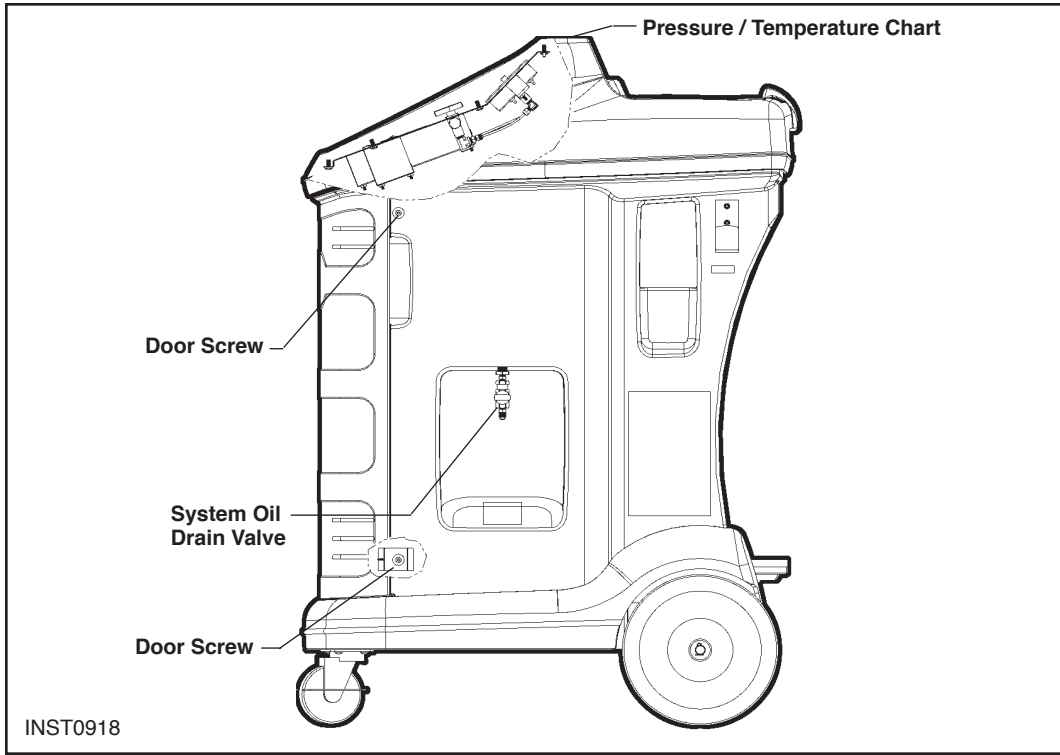

Diagram of Unit's Components — Side View

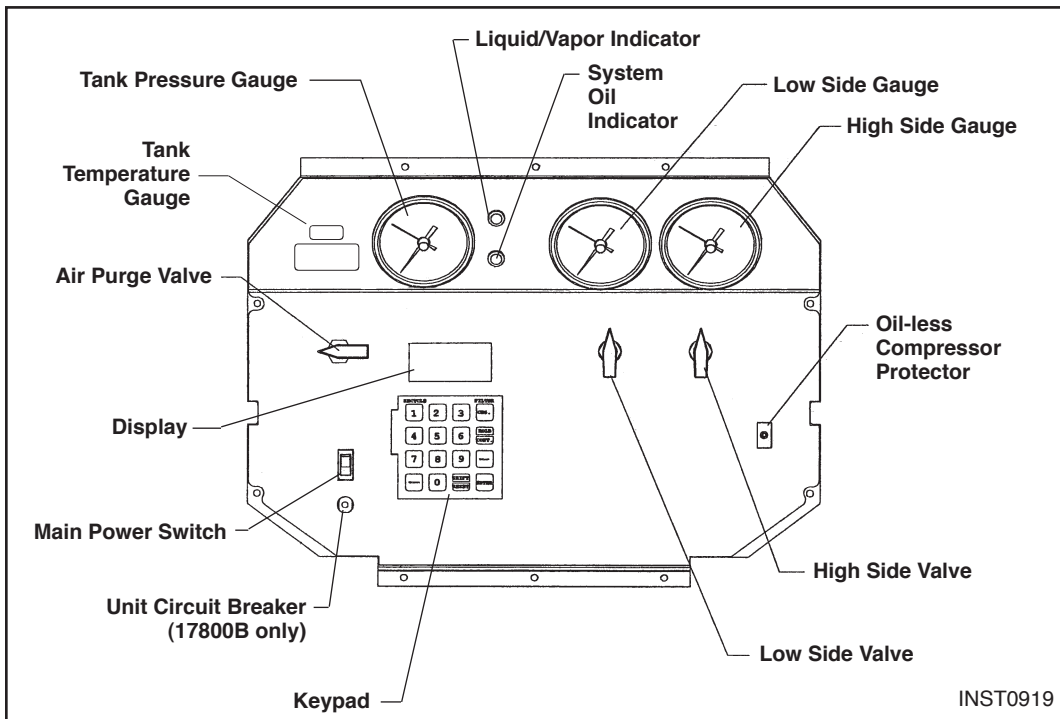

Diagram of Control Panel and Keypad

Setup Instructions

Before starting the set up procedures, open the system oil drain valve and allow the unit to depressurize.

1. Plug the unit into a correct voltage outlet.

⚠ WARNING: Avoid the use of an extension cord because the extension cord may overheat. However, if you must use an extension cord, use a No. 14 AWG minimum and keep the cord length to 25 feet (7.6 meters) or less.

2. Verify the oil drain valve on the side of the unit is in the **CLOSED** position.
3. Turn on the unit. The display flashes “door.” Slide the lockout door (in the upper left corner of the back of the unit) to expose the $\frac{1}{4}$ " flare fittings for R-12, or the $\frac{1}{2}$ " Acme fittings for R-134a. Then press **SHIFT/RESET** to continue.
4. Connect either of the automotive hose sets as follows:

- Connect the 36" red hose to the **RED** fitting on the back of the unit.
- Connect the 36" blue hose to the **BLUE** fitting on the back of the unit.
- Connect the 36" yellow hose to the **YELLOW** fitting on the back of the unit.

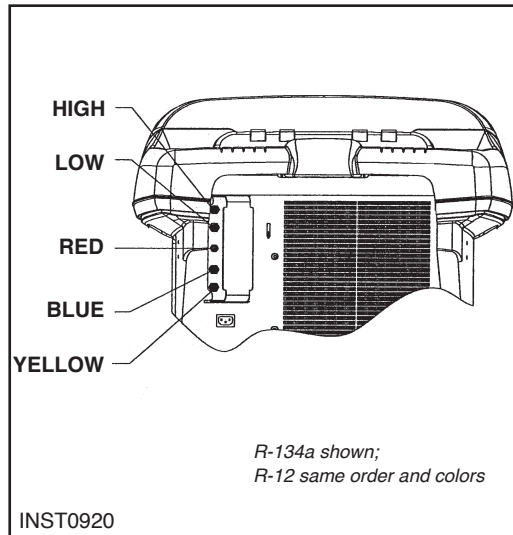
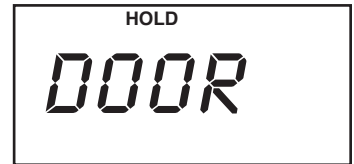
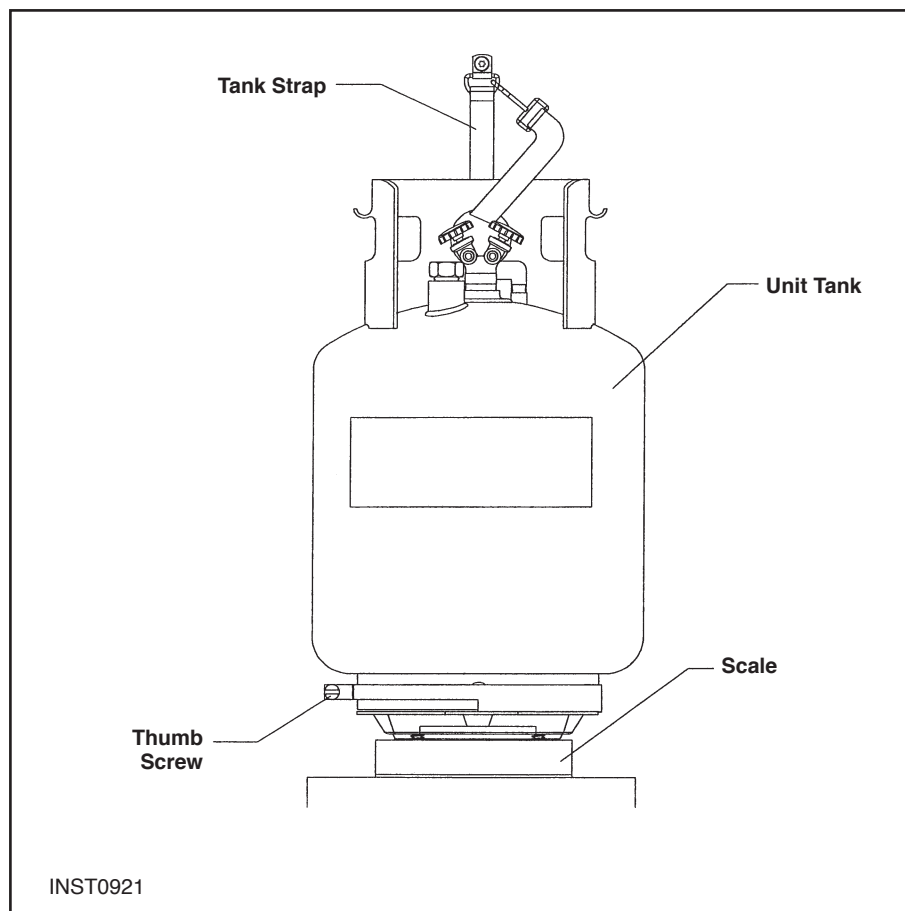

Diagram of Hose Connections — Lock-out Box

CAUTION: R-134a automotive systems have $\frac{1}{2}$ " Acme fittings (per SAE specifications) to avoid cross-contamination with systems using $\frac{1}{4}$ " flare fittings. Do not attempt to adapt your unit for the other refrigerant — system failure will result!

5. A new tank comes with a dry nitrogen charge of 5 to 10 psi to keep it clean and dry during shipment. Purge the nitrogen charge on the R-12 (gray and yellow) tank by opening the **GAS** (vapor) valve on the tank. Vent the pressure to the atmosphere; then close the valve.
6. Place the unit tank inside the ring on the scale platform on the back of the unit. Loop the tank strap through the tank collar, and secure the latch end of the strap to the metal loop at the other end of the strap. Use the thumb screw on the scale ring to tighten the tank to the scale platform.
7. Connect the 36" red hose to the red valve on the tank, and open the valve. Connect the 36" blue hose to the blue valve on the tank, and open the valve. Connect the 36" yellow hose to the air purge fitting on the tank.
8. Open both the low- and high-side valves on the control panel.



Placing the Tank on the Scale

Setup Instructions

CAUTION:
The pump must be running when adding oil. Do not overfill the pump. The approximate oil charge is 13 oz. (384 milliliters).

The VacuMaster® vacuum pump is shipped without oil in the reservoir. Before starting the unit, fill the pump with oil. Two 16-ounce (472 milliliters) bottles of oil are included with your unit.

9. Remove the door access screws from the right side of the unit. Open the door.
10. Remove the black plastic plug from the pump's oil fill port. Attach the flexible spout and cap to the bottle of oil included with your unit. This makes it easier to fill the pump.
11. Add one-half of a bottle of vacuum pump oil to the vacuum pump.
12. Press **SHIFT/RESET** and **ENTER** at the same time; then press "1." The vacuum pump will start and run continuously. While the pump is running, pour oil into the pump's oil fill port until the level of oil is even with the line of the pump reservoir sight glass. Replace the black plug on the oil fill port.
13. Let the pump run for about five (5) minutes to remove any air from the unit.
14. To turn off the pump, press **HOLD/CONT**. Then press **SHIFT/RESET** to exit the diagnostics mode.
15. Connect the blue 96" hose to the low side port, and the red 96" hose to the high side port on the back of the unit.

Before using a new tank, you must purge its nitrogen charge and pull it into a vacuum.

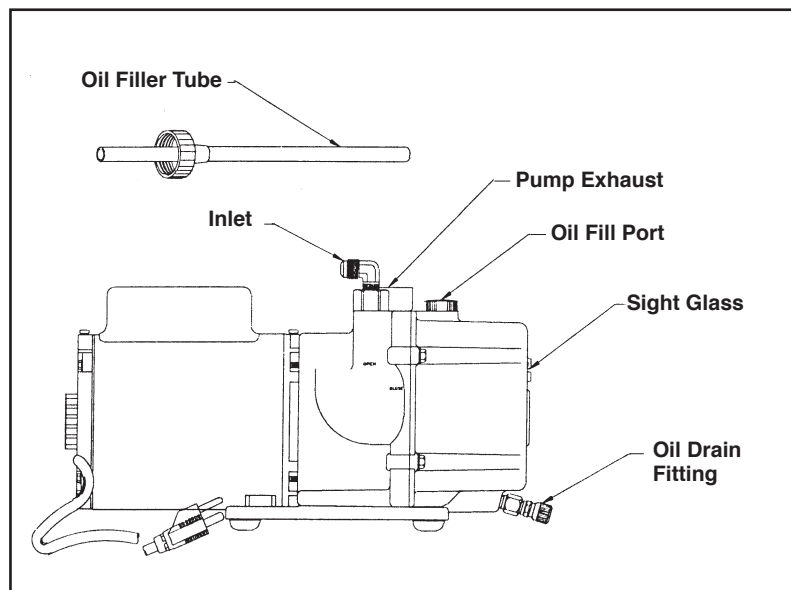

Diagram of Vacuum Pump Components

The 50 lb (23kg) unit tank must be filled with refrigerant before the unit is ready for use.

TANK FILL

1. Connect the 96" blue low-side hose to the liquid valve fitting on the source tank. If using R-134a, you may need the 1/2" acme to low-side adapter included in the accessory kit.

Note: Some tanks have slightly different valve configurations. Be sure to connect the blue hose to the LIQUID valve. This valve may be red on some tanks and blue on others.

2. Press **SHIFT/RESET** and **ENTER** at the same time; then press 2. The unit will begin transferring refrigerant from the source tank to the unit tank.
3. The unit will fill the recovery tank with up to 30 lbs of refrigerant and automatically stop. The display will flash "CPL" when the process is complete.

WARNING: To prevent personal injury,

- Wear safety goggles when working with refrigerant.
- Use only authorized refillable refrigerant tanks.
- Disconnect hoses using extreme caution!
- All hoses may contain refrigerant under pressure.
- Read and follow all warnings at the beginning of this manual before operating the unit.

RECOVERY PROCEDURES

WARNING:

Wear safety goggles when working with refrigerant. Use only authorized refillable refrigerant tanks. Disconnect hoses using extreme caution!

All hoses may contain refrigerant under pressure. Read and follow all warnings at the beginning of this manual before operating the unit.

Before beginning recovery, verify the unit is set up as described in the *Setup Instructions*. Also verify there is vacuum pump oil in the vacuum pump.

1. Connect the high- and low-side hoses to the A/C-R system, as you would normally connect your manifold gauge set.
2. Verify both the high- and low-side valves on the control panel are open. Also verify both valves on the tank are open.
3. Plug the unit into a correct voltage outlet, and turn on the **MAIN POWER** switch. The display shows either “134a” (which indicates R-134a automotive refrigerant that uses $\frac{1}{2}$ " Acme fittings) or “R12” (which indicates all other refrigerant types that use $\frac{1}{4}$ " flare fittings). The display may flash “door,” which indicates the unit is cleared and can be set up for any refrigerant type.
4. Press **RECOVER**.

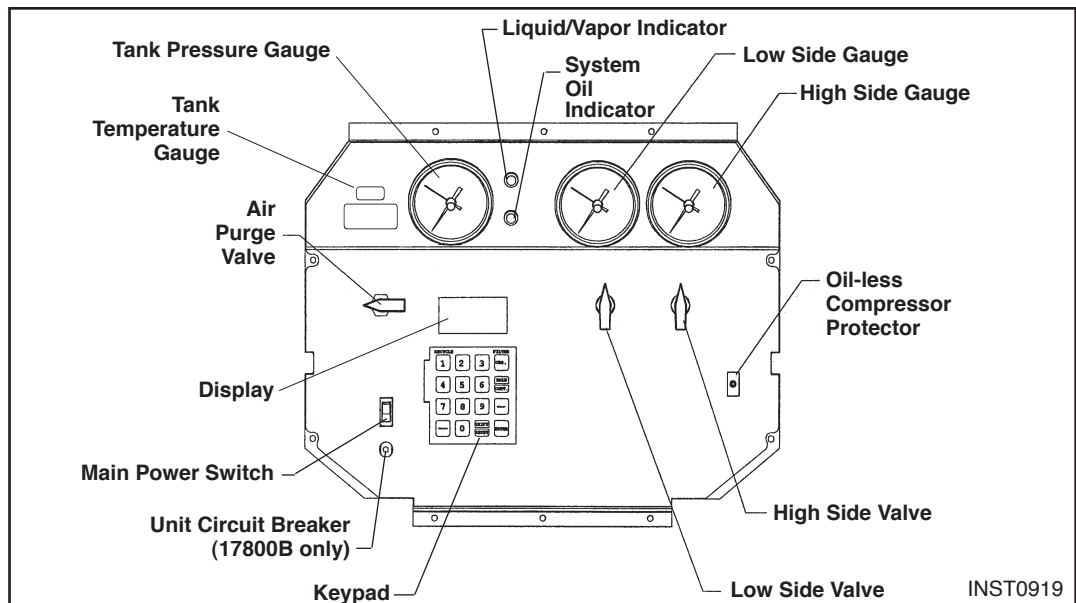

Diagram of Control Panel

Operating Instructions

The “CL-L” message shows on the display if there is pressure in the unit, and a self-clearing process of the components begins. You can press **HOLD/CONT** to bypass clearing if an accurate recovery amount is not required. Otherwise, the compressor will start and the “CL-L” message remains on the display. This process takes from 20 seconds to four minutes to complete. Once the clearing is complete, the unit automatically begins to recover refrigerant from the system. If there is no internal pressure in the unit, refrigerant recovery begins immediately.

CAUTION: If the A/C system pressure is 25 psi or less, the message “CH-P” appears on the display to alert you not to attempt recovery from an empty system. Do not press **HOLD/CONT** to continue the recovery process unless you know the A/C system contains refrigerant.

The display shows that the unit is in the RECOVER mode and the AUTOMATIC cycle. You can monitor the amount of refrigerant removed from the system by watching the display. The compressor shuts off automatically when recovery is complete (at approximately 13 inches of vacuum). The display shows the “CPL” message, and then alternately flashes the weight of refrigerant recovered.

5. To assure complete recovery of refrigerant, wait for five (5) minutes and watch the manifold gauges for a rise in pressure above “0.” If a rise occurs, press **HOLD/CONT**. Repeat as needed until the system pressure holds for two (2) minutes.

CAUTION: Drain the oil from the separator only after each recovery.

Do not completely depressurize the oil separator; immediately close the valve when oil is completely drained in the next step. The lower right corner of the display will indicate “OIL (OUNCES)” as a reminder.

6. Verify the oil catch bottle is empty, then *slowly* open the oil drain valve, and drain the oil into the oil catch bottle. This oil was removed from the A/C system during recovery. It must be replaced with new oil. When all the recovered oil has completely drained, immediately close the valve and record the amount of oil in the bottle. Dispose of waste oil in an appropriate manner.

If the recovery tank fills completely:

- The compressor shuts off; the digital display shows the message “FULL.”
- Change the tank.

The A/C system is now empty. Make any repairs at this time.

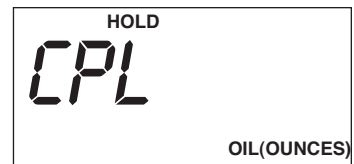
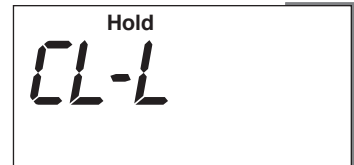

OIL(OUNCES)

FLASHES



Weight Example

LBS
RECOVER

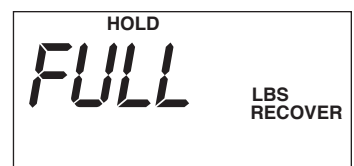

LBS
RECOVER

GLISH

NOTE:
Perform
“RECOVERY
PROCEDURES”
before starting
“CHANGING
REFRIGERANT
TYPES.”

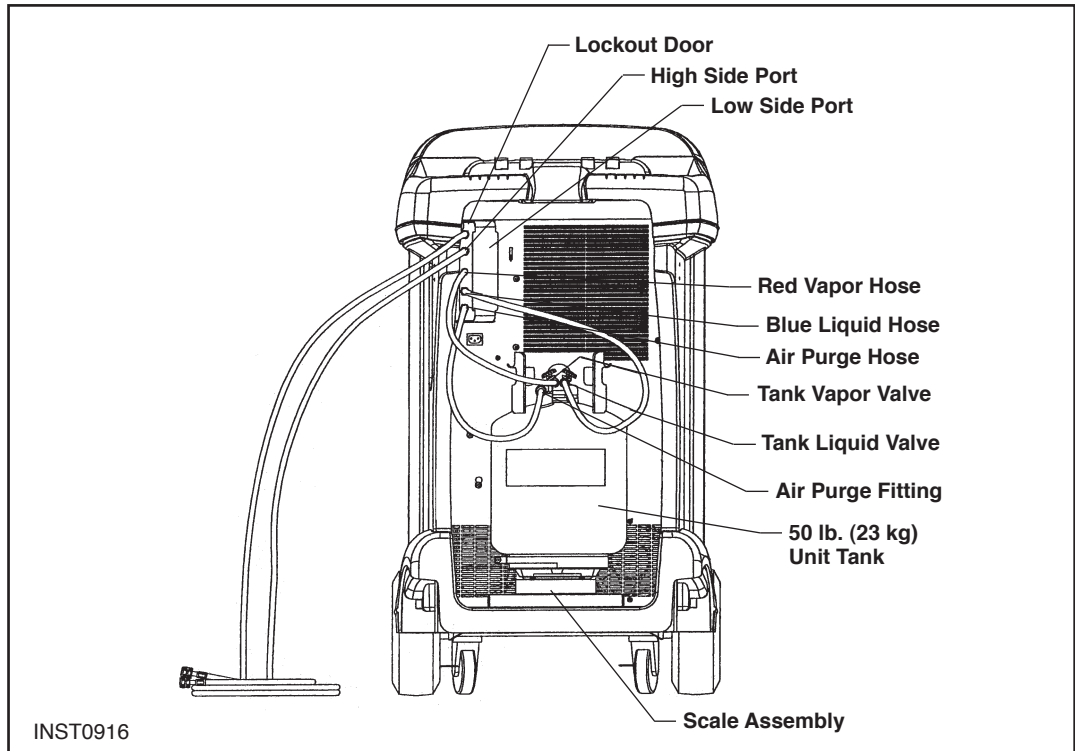

Diagram of Unit's Components — External View

CAUTION:
Before changing
refrigerant
types,
disconnect the
red high-side
and blue low-
side hoses from
the A/C system.

CHANGING REFRIGERANT TYPES

1. Verify the red high-side and blue low-side hoses are disconnected from the A/C system, then open the manifold and tank valves.
2. Press and release **SHIFT/RESET** until the “Clr” message appears.
3. Press **HOLD/CONT** to start the system oil separator clearing process.

During the system oil separator clearing process, the compressor is activated and the “OIL” message displays. The compressor will stop while the unit equalizes pressure and the “OIL” message will continue to display. When the unit reaches the correct pressure, the display alternately flashes the messages “OIL” and “drn.” Open the system oil drain valve to drain the oil. After all oil has drained, close the oil drain valve. The message changes to “Cont.” Press any key to complete the oil separator clearing process. When compressor stops again, the message changes to “CL-c.”

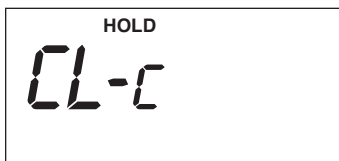

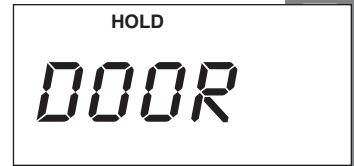

4. If you need to change hoses for the next refrigerant type, go to Step 5. If you do not need to change hoses, press **SHIFT/RESET** and go to Step 6.
5. To start the self-clearing process, press **VACUUM** while the “CL-c” message is displayed. The “Clr” message then displays and the vacuum pump runs for 5 minutes before shutting off automatically. The “door” message will then display.
6. Close the tank valves and disconnect the red, blue, and yellow hoses from the tank. Then remove the tank from the unit.
7. If you are using the same hoses for the next refrigerant type, go to Step 11. If you need to change the hoses, go to Step 8.
8. Disconnect all five (5) hoses from the lockout box fittings. If you need to change the door position on the lockout box, go to Step 9. If you do not need to change the door position, go to Step 10.
9. Slide the door on the lockout box to expose the fittings needed for the next refrigerant type.
10. Connect the correct hoses for the next refrigerant to the fittings in the lockout box.

Be sure to use the correct hose set for the refrigerant type selected:

Hose Set	Tank Hoses (3)	System Hoses (2)
R-134a automotive	36", 1/2" Acme with double Quick Seal	96", one Quick Seal with one quick coupler
R-12 automotive	36", 1/4" flare with double Quick Seal	96", 1/4" flare with double Quick Seal
All other refrigerant types	36", 1/4" flare with single Quick Seal	96", 1/4" flare with ball valve

11. Place a tank (already set up for the next refrigerant) on the unit. Connect the red, blue, and yellow hoses to the appropriate tank fittings.

The unit is now ready to process the next refrigerant type.

A/C-R SYSTEM EVACUATION

WARNING:

Wear safety goggles when working with refrigerant. Use only authorized refillable refrigerant tanks. Disconnect hoses using extreme caution!

All hoses may contain refrigerant under pressure. Read and follow all warnings at the beginning of this manual before operating the unit.

1. Verify the high- and low-side hoses are connected to the A/C-R system, and that the high- and low-side valves are open.
2. Press **SHIFT/RESET** to toggle the display to show “PROGRAM VACUUM MINUTES 15.00.” Fifteen minutes is the default time for evacuation. To change the time, press the appropriate keys to display the desired time. Then press **ENTER**.

The longest time that can be programmed is 98.99 (98 minutes and 99 seconds).

3. Press **VACUUM** to start evacuation. The display counts down the time remaining. If the message “U-HI” appears, you have 25 psi or greater of pressure at the inlet. You must recover that pressure to continue. If necessary, press **RECOVER**.
4. When the programmed time has expired, the vacuum pump automatically shuts off and the display shows “CPL.” Press any key to exit vacuum mode.

To run the vacuum pump continuously, program the time to “99.00,” press **ENTER**, then press **VACUUM**. The pump will start and the display will show “CON AUTOMATIC VACUUM.” To turn the vacuum pump off, press **HOLD/CONT**.

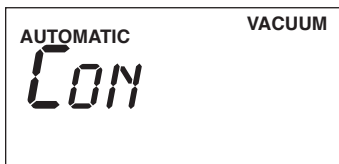
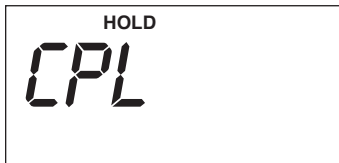
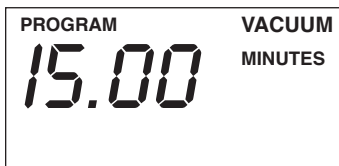

RECYCLING PROCEDURES

! WARNING:

Wear safety goggles when working with refrigerant. Use only authorized refillable refrigerant tanks. Disconnect hoses using extreme caution!

All hoses may contain refrigerant under pressure. Read and follow all warnings at the beginning of this manual before operating the unit.

1. Verify both valves on the tank are open.
2. Press and hold **SHIFT/RESET**, then press “1” to start the recycling process.

If the recovery tank is full, the display will show the message “FULL.” Press **HOLD/CONT** to resume operation.

3. After about five (5) minutes of recycling, the tank temperature should equalize. You can then purge non-condensables.
4. To purge non-condensables, check the tank temperature gauge to find the temperature of the refrigerant. Use that temperature to find the correct pressure for that refrigerant on the pressure/temperature chart on the top of the unit. Compare the pressure from the chart to the pressure shown on the tank pressure gauge. If the gauge pressure exceeds the target pressure by more than 10 psi, open the air purge valve on the control panel for about 30 seconds to release non-condensables from the tank. Then close the air purge valve and allow the tank to stabilize for about 30 seconds. Check the tank pressure gauge again. Repeat this step as necessary during the recycling procedure.

Note: The tank temperature display can show Fahrenheit or Celsius degrees. Refer to *Changing the Temperature Scale* in this manual.

5. To stop recycling, close the tank’s LIQUID valve. The unit will pull into a vacuum and shut off automatically. Press any key to exit recycle mode.

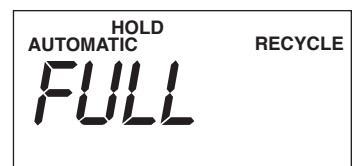

CAUTION:
You can stop recycling instantly by pressing **HOLD/CONT**, then **SHIFT/RESET**, but this can leave liquid refrigerant in the low side of the unit. Closing the tank’s **LIQUID** valve is the recommended method.

CHARGING PROCEDURES

WARNING:

Wear safety goggles when working with refrigerant. Use only authorized refillable refrigerant tanks. Disconnect hoses using extreme caution!

All hoses may contain refrigerant under pressure. Read and follow all warnings at the beginning of this manual before operating the unit.

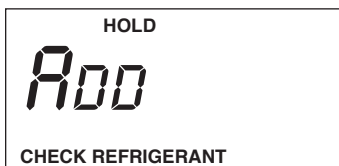

The unit will display the message “CHECK REFRIGERANT” if there are less than six (6) pounds of refrigerant in the tank. The charging system will not function if this message is displayed. If you try to charge in this situation, the display will also show “Add HOLD” to let you know that refrigerant needs to be added to the tank.

Add more refrigerant to the tank than what is needed for charging (see *Adding Refrigerant to the Tank*). To check the weight of refrigerant in the tank, press and hold **SHIFT/RESET**, then press **ENTER** to access the diagnostic mode. Press “7” to display the weight of refrigerant in the tank. Press **SHIFT/RESET** again to exit the diagnostic mode.

Follow the A/C-R system manufacturer’s instructions regarding specific recharging specifications. You must replace any oil lost from the A/C-R system during recovery with new oil. Dispose of waste oil in an appropriate manner.

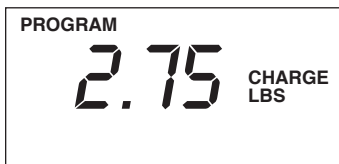

*Weight Example**

1. Open the high-side valve and, if allowable, the low-side valve on the unit’s control panel.
2. Press **SHIFT/RESET** until the message “CHG” appears on the display.
3. Press **CHG** and enter the weight of the refrigerant to be charged.
4. Press **ENTER**. The display will flash to indicate that the charge amount has been recorded in the unit’s memory.
5. Press **CHG** again to begin the charging process.
6. The display will show the message “AUTOMATIC” and the amount programmed for recharging. The display counts down to zero as charging proceeds.
7. When charging is complete, the display shows the message “CPL.”

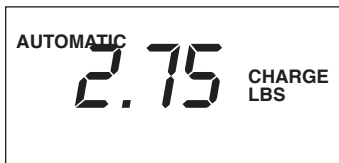

*Weight Example**

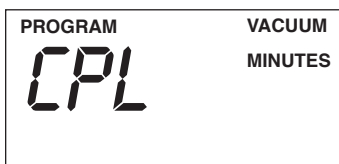

**Enter the correct weight for your application.*

If the unit beeps continuously, the transfer of refrigerant has stopped before the charging procedure was completed (see *Correcting An Incomplete Transfer*).

8. Close the high- and low-side valves on the control panel, and start the A/C-R system. Compare the gauge readings to the manufacturer's specifications.
9. Turn off the A/C-R system, and disconnect the high-side hose from it.
10. Start the A/C-R system, and open both the high- and low-side valves. This pulls the portion of the programmed charge that is trapped in the hoses into the low side of the A/C-R system.
11. At the lowest recommended operating pressure, close the low-side valve and turn off the A/C-R system. Disconnect the low-side hose from the system.
12. Close the high-side valve, and turn off the **MAIN POWER** switch.

CORRECTING AN INCOMPLETE TRANSFER

If the scale value does not change for 30 seconds, the unit beeps continuously to indicate that the transfer of refrigerant was not completed. There are two reasons for an incomplete transfer of refrigerant:

- The pressure in the A/C-R system is equal to the pressure in the tank. The unit produces an audible signal and shows the weight remaining to complete the transfer.
 1. Close the high-side valve on the control panel.
 2. Disconnect the high-side hose from the A/C-R system.
 3. Continue with Step 9 in *Charging Procedures*.
- The display shows the message "CHECK REFRIGERANT" because there is not enough refrigerant in the tank.
 1. Press **HOLD/CONT** to interrupt the transfer.
 2. Verify both valves on the tank are closed, then disconnect and remove the tank from the unit. Replace it with a tank containing additional refrigerant.
 3. Press **HOLD/CONT** again to resume the transfer.

ADDING REFRIGERANT TO THE TANK

CAUTION: R-134a systems have special fittings (per SAE specifications) to avoid cross-contamination with other refrigerant systems. Read and follow all warnings given at the beginning of this manual.

CAUTION:
When setting up for new types of refrigerant, a clearing process must be performed.

NOTE: Purchase only tanks of R-134a refrigerant that have 1/2 inch (1.2cm) Acme threads. This is necessary to match the hose adapter.

1. Connect the 96-inch (244 cm) blue low-side hose to the unit's low-side port.

NOTE: Disposable tanks have only one valve and most must be turned upside down to transfer liquid. If you are using a disposable tank, follow the instructions on the side of the tank to obtain a liquid supply.

2. **When using R-12**, connect the 6-inch (15.2-cm) yellow adapter to the source tank liquid valve *first*. Then connect the 96-inch (244-cm) blue low-side hose to the adapter.

When using R-134a, connect the low-side connector port adapter to the source tank liquid valve *first*. Then connect the blue 96-inch (244-cm) low-side hose directly to the adapter.

3. Open the LIQUID valve on the source tank. (There is only one valve on a non-refillable tank.)
4. Close the high-side manifold valve, and open the low-side manifold valve on the front panel of the unit. Open both valves on the unit tank.
5. Press **SHIFT/RESET** and **ENTER** at the same time to access the diagnostic mode. The display shows the message "FUNC."
6. Press **2** to begin transferring refrigerant. The display shows the "Add" message for about two seconds, then shows the amount of refrigerant transferred.

(continued)

Operating Instructions

- Transfer stops automatically and the display shows the “CPL” message when the source tank is empty and has been pulled to a partial vacuum **or** the weight of refrigerant in the unit tank reaches 37 pounds. The display toggles between “CPL” and the weight in the tank.

This process takes about 45 minutes. You can interrupt it at any time by pressing **HOLD/CONT** once. Press **HOLD/CONT** again to resume operation, or press **SHIFT/RESET** to end the process. The transfer of new refrigerant is limited by weight to leave space (about 6 pounds of refrigerant) in the unit tank for recovery purposes.

- When using R-12**, close the supply valve on the source tank (when using a disposable tank, turn it right side up first). *Carefully* disconnect the 96 inch (244-cm) blue low-side hose from the 6-inch (15.2-cm) yellow adapter, and then remove the yellow adapter from the source tank.

When using R-134a, close the supply valve on the source tank, (when using a disposable tank, turn it right side up first). *Carefully* disconnect the 96 inch (244-cm) blue low-side hose from the low-side connector port adapter and then remove the adapter from the source tank.

- Press **RECOVER**. The hose will be pulled into a partial vacuum and the unit will turn off automatically. If the hose is partially clear, the unit will display “CH-P.” Press **HOLD/CONT** to finish clearing the hose. Close the low-side manifold valve.
- Connect the 96-inch (244-cm) red high-side hose to the unit’s high-side port. You can also attach an oil injector to the unit’s low-side port. Oil injectors will not connect to the wrong ports. The R-12 oil injector has a 1/4 inch flare connector; the R-134a oil injector has a 1/2 inch Acme connector.

Any non-condensable gases in the tank can be removed during the recycling sequence. Your unit is now ready for use.

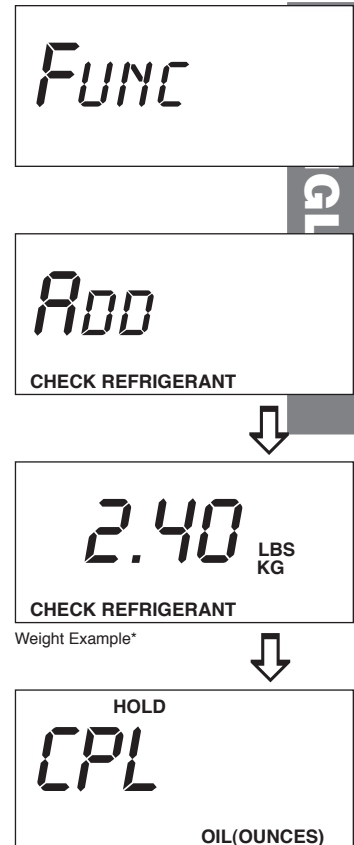

* The display shows the weight of refrigerant added to the tank.

NOTE:

Close both tank valves when the unit is not in use. Inspect the unit periodically for leaks. The manufacturer of the recovery/recycling unit does not reimburse for lost refrigerant.

This overview is designed as a quick reference when using your unit. Read and follow all warnings in the operating manual.

RECOVERY OVERVIEW

1. Connect the high- and low-side hoses to the A/C-R system.
2. Check the manifold gauges. There must be pressure to recover refrigerant.
3. Verify both the high- and low-side valves on the control panel are open. Also verify both valves on the tank are open.
4. Plug the unit into a correct voltage outlet, then turn on the **MAIN POWER** switch.
5. Press **RECOVER**:
 - If there is pressure in the unit, the self-clearing process starts.
 - If there is no internal pressure, refrigerant recovery begins.
 - The unit then shows “RECOVER AUTOMATIC” and the weight of refrigerant being recovered into the tank.
6. Once the recovery and/or self-clearing procedure is complete, the compressor shuts off automatically. The display will flash “CPL” and the weight of refrigerant recovered.
7. If the A/C-R system pressure rises above zero, press **HOLD/CONT** to recover the remaining refrigerant.
8. The display also shows “OIL (OUNCES).” This is a reminder to drain the system oil separator into a suitable container by opening the ball valve on the side of the unit.

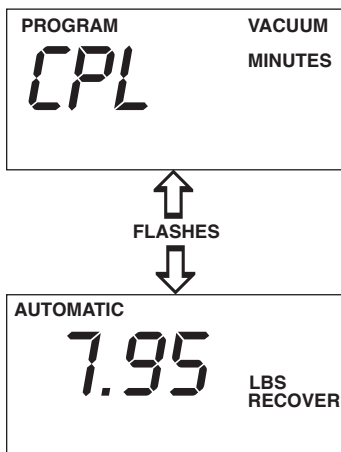

Weight Example

You must replace any oil lost from the A/C-R system during recovery with new oil. Dispose of waste oil in an appropriate manner.

EVACUATION OVERVIEW

1. Verify the high- and low-side hoses are connected to the A/C-R system, and that the high- and low-side valves are open.
2. Press **SHIFT/RESET** to toggle the display to show “PROGRAM VACUUM MINUTES 15.00.” Fifteen minutes is the default time for evacuation. To change the time, press the appropriate keys to display the desired time. Then press **ENTER**.

Note: *The longest time that can be programmed is 98.99 (98 minutes and 99 seconds).*

3. Press **VACUUM** to start evacuation. The display counts down the time remaining. If the message “U-HI” appears, there is 25 psi or greater of pressure at the inlet. You must recover that pressure to continue. If necessary, press **RECOVER**.
4. When the programmed time has expired the vacuum pump automatically shuts off and the display shows “CPL.”

To run the vacuum pump continuously, program the time to “99.00,” press **ENTER**, then press **VACUUM**. The pump will start and the display will show “CON AUTOMATIC VACUUM.” To turn the vacuum pump off, press **HOLD/CONT**.

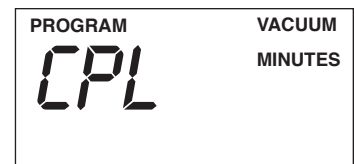
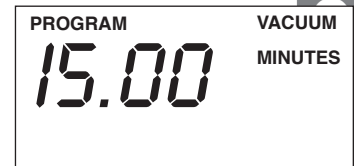

RECYCLING OVERVIEW

1. Verify both valves on the tank are open. Press and hold **SHIFT/RESET** and then press “1” to start the recycling process.
2. When the tank temperature equalizes (after about five minutes of recycling time), purge non-condensables from the tank. To purge, use the temperature gauge to determine the temperature of the refrigerant. Then use the pressure/temperature chart on the top of the unit to determine the correct pressure for that refrigerant. If the gauge pressure exceeds the target pressure by more than 10 psi, open the air purge valve for about 30 seconds and release non-condensables from the tank.
3. Close the air purge valve and let the tank stabilize (about 30 seconds). Check the air purge gauge again. Repeat Steps 2 and 3 as necessary during the recycling process.
4. Close the tank's LIQUID valve to stop the recycling process. The unit will pull into a vacuum and shut off automatically.

CAUTION:
You can stop recycling instantly by pressing **HOLD/CONT**, then **SHIFT/RESET**, but this can leave liquid refrigerant in the low side of the unit. Closing the tank's LIQUID valve is the recommended method.

CHARGING OVERVIEW

Follow the manufacturer's recommendation for charging. You must replace any oil lost from the A/C-R system during recovery with new oil. Dispose of waste oil in an appropriate manner.

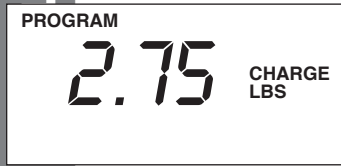

*Weight Example**



*Weight Example**

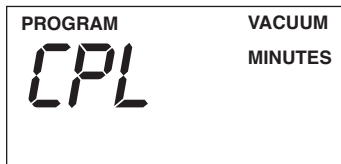

**Enter the correct weight for your application.*

1. Open the high-side valve and, if allowable, the low-side valve.
2. Press **CHG** and enter the weight of the refrigerant to be charged.
3. Press **ENTER**, then press **CHG** again. The display counts down to zero, then shows the "CPL" message when complete.
4. Close the high- and low-side valves and start the A/C-R system. Compare the gauge readings to the manufacturer's specifications.
5. Turn off the A/C-R system and disconnect the high-side hose from it.
6. Start the A/C-R system and open both manifold valves to pull refrigerant from the hoses.
7. At the lowest recommended operating pressure, close the low-side valve and turn off the A/C-R system. Disconnect the low-side hose.
8. Close both manifold valves and turn off the **MAIN POWER** switch.

CHANGING THE VACUUM PUMP OIL

When the vacuum pump has run for a total of 10 hours, the “OIL” message will flash on the display to signal that an oil change is needed. To change the vacuum pump oil, follow these steps:

1. Turn on the **MAIN POWER** switch. The display shows the selected refrigerant type.
2. Press **SHIFT/RESET** and the message “PROGRAM VACUUM MINUTES 15:00” displays.
3. Press **VACUUM**. The display shows the “OIL” message.
4. Remove the door access screws from the right side of the unit. Open the door.
5. Remove the black plastic plug on the oil fill port.
6. Remove the oil drain cap from the vacuum pump, then drain the contaminated oil into a suitable container. (Dispose of it according to local, state, and federal regulations). Replace the oil drain cap.
7. Attach the flexible spout and cap to the oil bottle, and pour approximately six (6) ounces of vacuum pump oil into the oil fill port.
8. Verify the manifold valves are closed, then press **SHIFT/RESET** and **ENTER** at the same time to reset the ten-hour timer.
9. Press **VACUUM**. While the pump is running, *slowly* add new vacuum pump oil until the oil level is even with the line on the reservoir’s sight glass.
10. Replace the black plastic plug on the oil fill port.

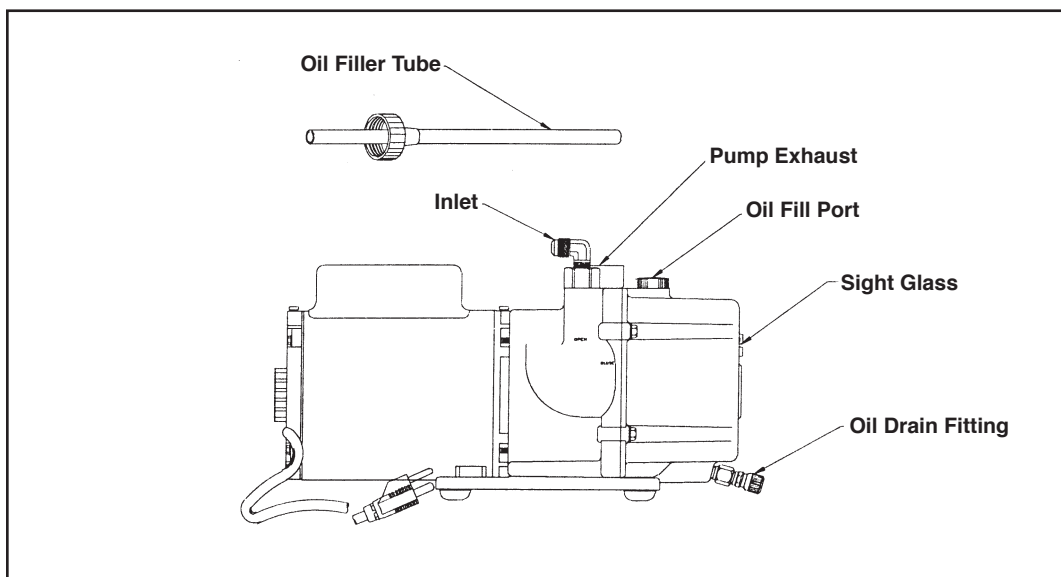
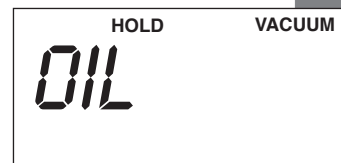
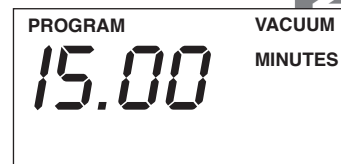
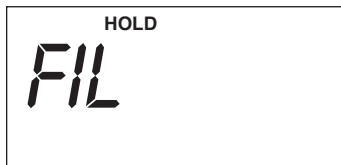
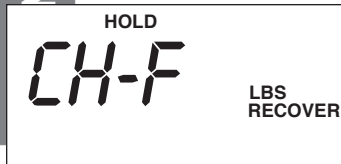

Diagram of Vacuum Pump Components

CHANGING THE FILTER-DRIER

Change the filter-drier whenever refrigerant has been recovered from a burn-out system or when the display shows the “CH-F” message (which means that the unit has recovered 200 pounds of refrigerant since the last change). To change the filter/drier follow these steps:



1. Press and hold **SHIFT/RESET** and then press **FILTER**. The compressor will start and the display will show the messages “FIL” and “AUTOMATIC.”
2. The compressor will shut off when the vacuum switch trips, and the display will show the messages “FIL” and “HOLD.”
3. Turn off the **MAIN POWER** switch and unplug the unit.
4. Remove the door access screws from the right side of the unit. Open the door.
5. Disconnect the hose from the top of the filter-drier, and unscrew the filter-drier by rotating it counterclockwise. (You may need a 5/8" wrench to break it loose.)
6. Open the new filter-drier, and generously lubricate the o-ring with vacuum pump grease. Also lubricate the gasket in the end of the hose that connects to the top of the filter-drier.
7. Replace the greased o-ring into the groove in the manifold. Screw the new filter-drier into place. Reattach the hose with the greased gasket to the top of the filter-drier.
8. Close the cabinet door, and replace the door access screws.
9. Turn on the **MAIN POWER** switch.
10. Press **HOLD/CONT**. The vacuum pump will start, the display will show the messages “FIL AUTOMATIC,” the pump will run for about two minutes, and then shut off. The display will show the message “CPL.”

This procedure automatically resets the filter-drier change counter for another 200 pounds of refrigerant.

CAUTION:
Do not remove the new filter-drier from its sealed bag until you are ready to use it.

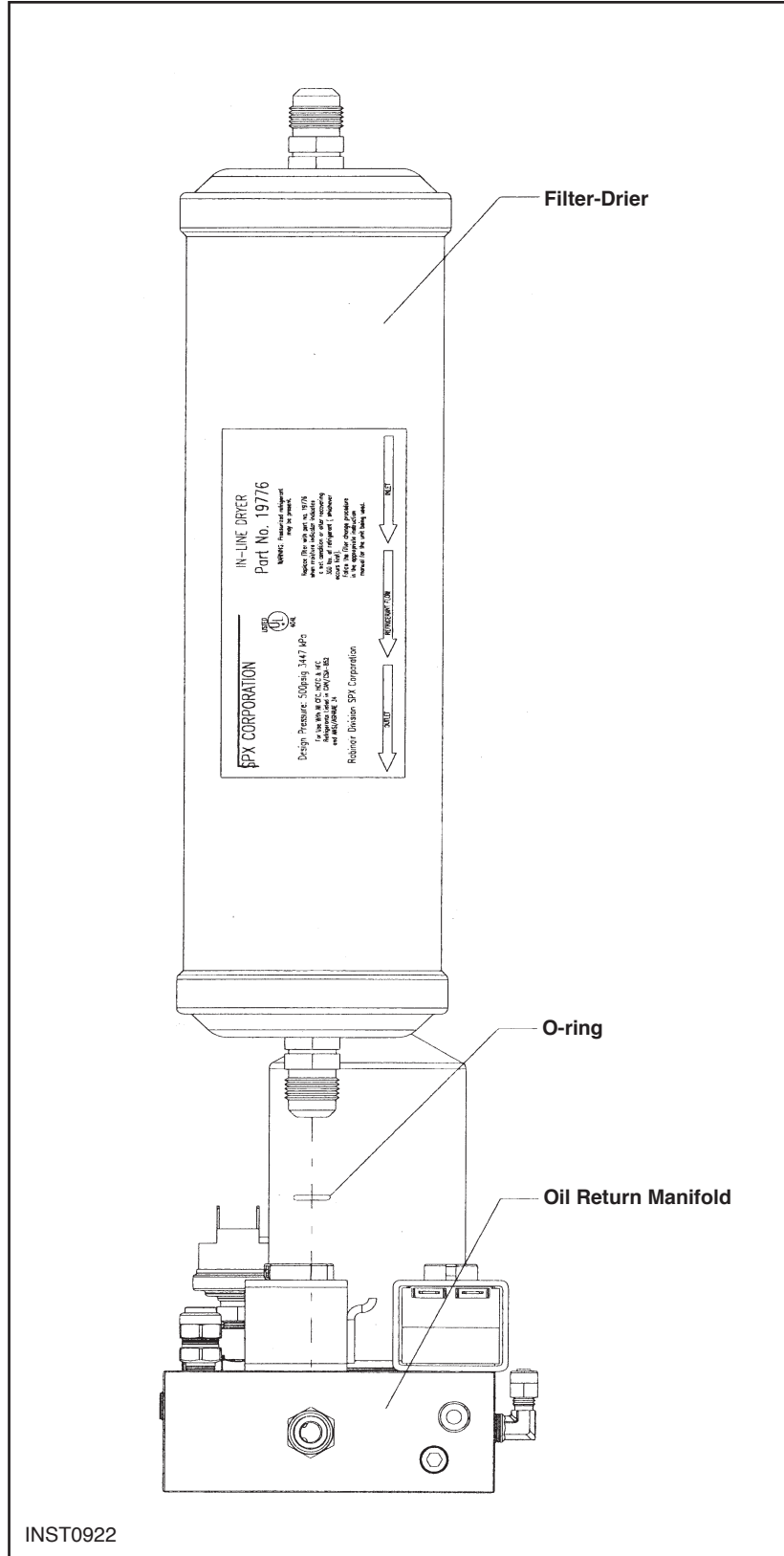

Diagram of Filter-Drier

CONFIRMING THE SCALE CHECKLIST

Blank Display or No Warnings

Check the wire connections from the scale assembly to the circuit board for configuration and continuity.

NOTE:

Check the scale accuracy every three months.

Verify the circuit board is receiving the correct voltage (refer to the decal on the back of the unit), and the two amp or 1/2 amp fuse is not blown. Use correctly grounded, active, electrical outlets only. Replace the circuit board or fuses as needed.

Total Amounts Not Accurate

Verify that nothing is touching, blocking, or interfering in any way with the scale assembly, tank, or hoses. Confirm that the total weight on the scale assembly is not exceeding 80 lb/37 kg. If it is, reduce the amount of refrigerant in the tank.

Full (Full Tank Setting)

The compressor will shut off at the weight previously set. To check the weight of the tank, scale, and refrigerant being recovered, follow the appropriate sections found under *Using the Diagnostic Mode*.

CORRECT WEIGHT VERIFICATION

1. Turn on the **MAIN POWER** switch.
2. Press **SHIFT/RESET** until “PROGRAM” displays.

NOTE: *If the unit is just being turned on, the screen will default to display the selected refrigerant type. Press **SHIFT/RESET** until “PROGRAM” displays.*

3. When the “PROGRAM” message displays, press and hold **SHIFT/RESET**, then press **ENTER**. The “FUNC” message will display when the manual diagnostic mode has been accessed correctly.
4. Remove all weight from the scale platform.
5. Press **6** to turn the scale into a direct-reading weight scale.

NOTE: *Any weight on the scale when **6** is pressed will not be shown on the display. The unit automatically zeros the weight on the scale when **6** is pressed. If you remove the weight, the display will show the change in total weight, but will not show a negative sign.*

6. Place a known weight of between 30-60 lbs./13-28 kg on the scale. The display will show the known weight “± .04lb./02 kg.”



FUNC

7. If the scale does not read the weight accurately, recalibrate the scale and UL circuit using the following instructions. If the scale does not respond to testing, verify the scale cable is plugged into the main circuit board.
8. Press **SHIFT/RESET** to exit this mode

CALIBRATING THE SCALE



NOTE: *The scale assembly and UL circuit MUST be calibrated when installing a replacement scale assembly or circuit board. To ensure continued charging accuracy, periodically confirm the checklist below.*

1. Remove all weight from the scale platform.
2. Turn on the **MAIN POWER** switch.

NOTE: *If the unit is just being turned on, the screen will default to display the selected refrigerant type.*

3. Press **SHIFT/RESET** and **ENTER** until “PROGRAM” displays.
4. When the “PROGRAM” message displays, press **SHIFT/ RESET** at the same time. The “FUNC” message displays.
5. Press **9**. The display is blank.
6. Press **RECOVER** and **ENTER** at the same time.
7. The DATE message flashes, then “0.00” displays. Enter the current month and year. For example, if the unit is being calibrated on November 8th, 1998, enter **1,1,9,8** and then press **ENTER**.
8. The “CAL” message will flash, then the “ZERO” message displays.
9. Verify nothing is on or touching the scale platform, then press **ENTER**.
10. The “CAL” message will flash, then the “A1” message displays.
11. Place a certified weight (between 20 and 70 lbs.) in the center of the scale platform. Enter the weight from the display. For example, to record 20 lbs. on the scale, press “**2,0,0,0**” on the keypad, then press **ENTER**. The display returns to the vacuum mode.

12. To check scale accuracy, follow the *Correct Weight Verification* procedure.

 WARNING 
Unplug the unit before beginning service work. Incorrect use or connections can cause electrical shock. Only qualified personnel should perform service work.
If scale assembly and UL circuit are not calibrated, scale can overflow the tank, causing possible explosion and/or vehicle overcharge.

UL CIRCUIT CALIBRATION

NOTE: Always calibrate the scale first. Then remove the (4) screws that hold down the keypad on the control panel before attempting to calibrate the UL circuit.

1. Remove all weight from the scale platform.
2. Turn on the **MAIN POWER**.

NOTE: If the unit is just being turned on, the screen will default to display the selected refrigerant type.

3. Press **SHIFT/RESET** until “PROGRAM” displays.
4. When the “PROGRAM” message displays, press **SHIFT/RESET** and **ENTER** at the same time. The “FUNC” message displays.
5. Press **6**.

NOTE: Any weight on the scale when **6** is pressed will not be shown on the display. The unit automatically zeros the weight on the scale when **6** is pressed. If you remove the weight, the display will show the change in total weight, but will not show a negative sign.

NOTE:
You must have
a known weight
of 75 lb. \pm .01
(34.02 kg \pm .005).

6. Place a known weight of EXACTLY 75 lbs. on the scale platform. The display will show “75 lb. \pm .04 lbs/.02kg.”
7. Adjust the potentiometer (P1 POT) set screw just until the “HOLD” message displays. (The potentiometer adjusting screw is located on the circuit board.)

NOTE: Turning the P1 POT clockwise increases the weight capacity of the scale. Turning the P1-POT counterclockwise decreases the weight capacity of the scale.

8. Lift the weight from the scale and “HOLD” should appear.

NOTE: The display should read “HOLD” for 75 lbs. ONLY, not for anything more or less.

9. If the UL circuit won't calibrate, replace the main circuit board.

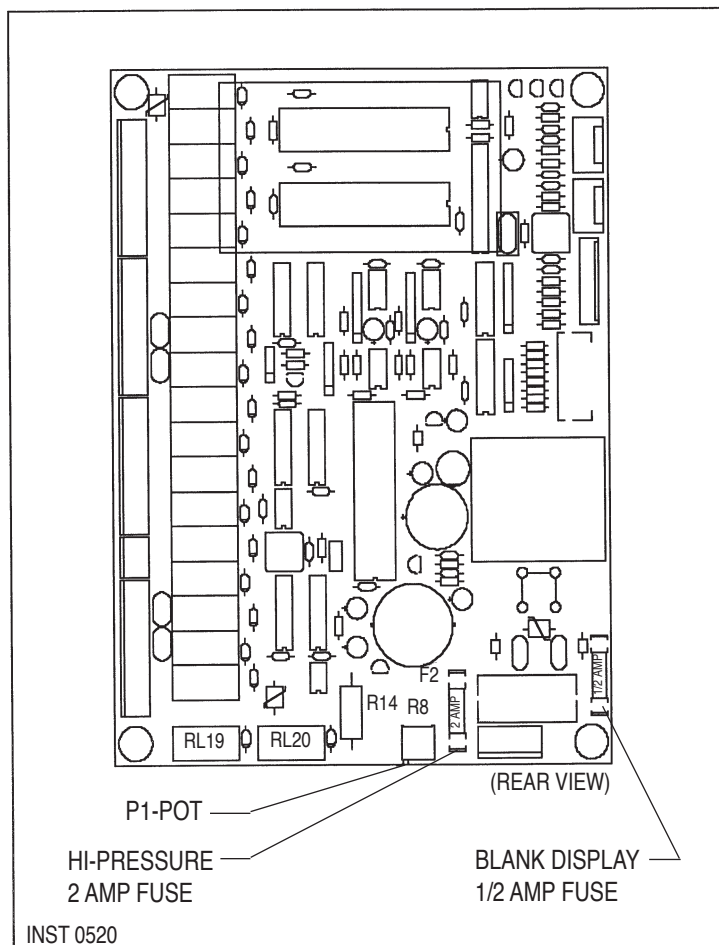

NOTE:
Inspect the unit periodically for leaks. The manufacturer does not reimburse for lost refrigerant.

CHECKING FOR LEAKS

Every three months, or as often as required by local or state laws, check the unit for leaks. As with any mechanical equipment, general use, moving the unit, and vibration can cause fittings to loosen.

1. Turn off the **MAIN POWER** switch, and disconnect the power cord from the outlet.
2. Remove the door access screws from the right side of the unit. Open the door.
3. Use a leak detector to probe all fitting connections for refrigerant leaks. Tighten fittings if a leak is indicated.
4. Close the door and replace the door access screws.

CHANGING THE TEMPERATURE SCALE— FAHRENHEIT OR CELSIUS

The temperature scale is set at the factory. Use the following steps to toggle the temperature scale between Fahrenheit and Celsius.

1. Turn off the **MAIN POWER** switch, and disconnect the power cord from the outlet.
2. Remove the four screws that secure the top section of the unit's protective covering, and remove the covering.
3. Locate the selector switch on the back of the tank temperature display.

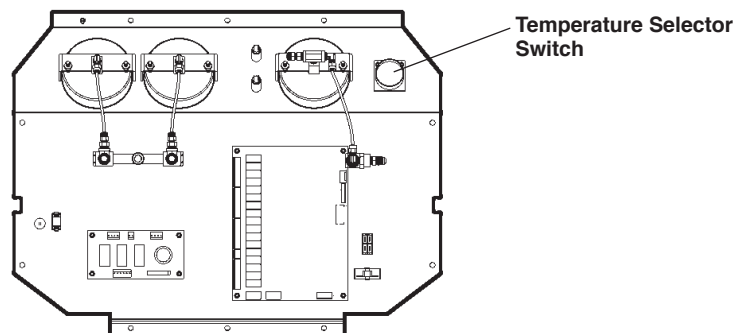

4. Change the position of the switch to change the temperature scale.
5. Replace the top section of the unit's protective covering, and replace the four screws that secure the covering.

USING THE CONTROL PANEL

MAIN POWER Switch — Supplies electrical power to the control panel.

Digital Display — Shows the time programmed for vacuum, and the weight of refrigerant programmed for recharging. Detailed instructions for programming the digital display follow this section.

Air Purge Indicator — Shows when non-condensables need to be purged from the tank.

LIQUID/VAPOR Indicator — Shows if liquid or vapor refrigerant is being recovered.

System Oil Indicator — Shows when the system oil separator is full and an oil drain needs to be performed.

Low-side Manifold Gauge — Connects to an A/C-R system and shows the system's low-side pressure.

High-side Manifold Gauge — Connects to an A/C-R system and shows the system's high-side pressure.

High-side Valve — Controls the high-side flow from the A/C-R system through the unit.

Low-side Valve — Controls the low-side flow from the A/C-R system through the unit.

Air Purge Valve — Controls the release of non-condensables from the tank.

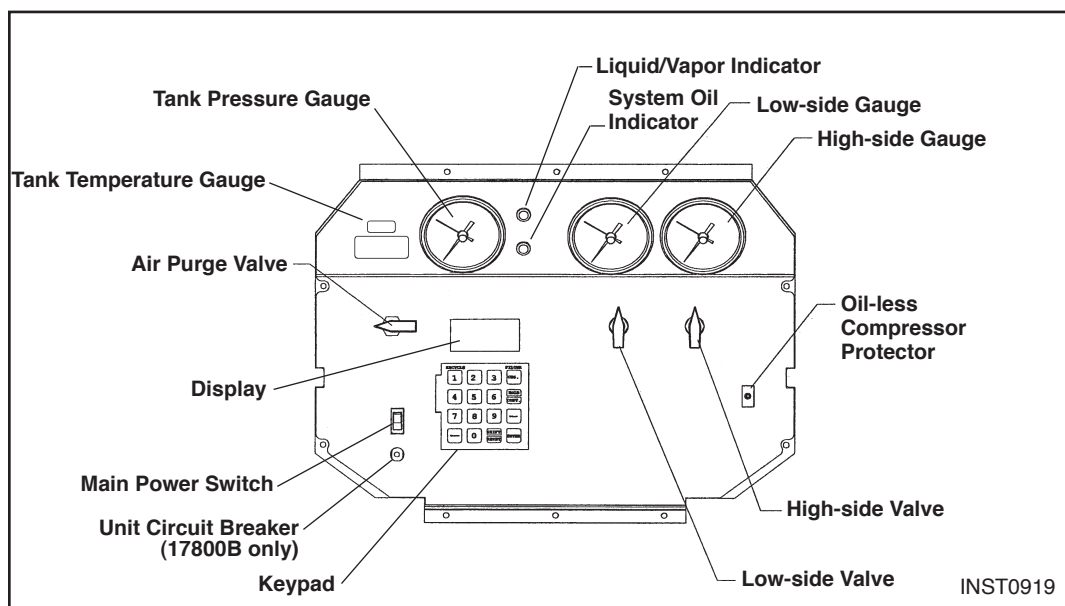

Diagram of Control Panel

KEYPAD FUNCTIONS

In addition to the number keys, the keypad contains special keys that accomplish specific operating functions.

- **RECYCLE** — Activates the recycling sequence when pressed at the same time as the **SHIFT/RESET** key.
- **RECOVER** — Activates the recovery sequence.
- **SHIFT/RESET** — Accesses the “PROGRAM” mode and moves from one program function to the next.
- **FILTER** — When pressed at the same time as the **SHIFT/RESET** key, automatically recovers and evacuates to 13 inches of vacuum from the filter and low side of the unit so you can change the filter.
- **CHG** — Automatically charges the A/C-R system with the programmed amount of refrigerant.
- **HOLD/CONT** — Interrupts the “AUTOMATIC” cycle (**HOLD**), and then resumes functions (**CONT**). Press once for **HOLD**, and again for **CONT** (continue).
- **VACUUM** — Activates the vacuum process.
- **ENTER** — Enters programmed data into the unit’s memory.

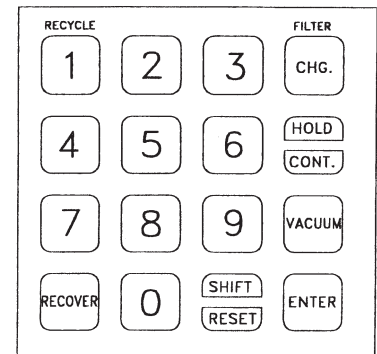

Diagram of Keypad

USING THE DIGITAL DISPLAY

This section explains the messages shown on the digital display, which is illustrated here for your convenience.

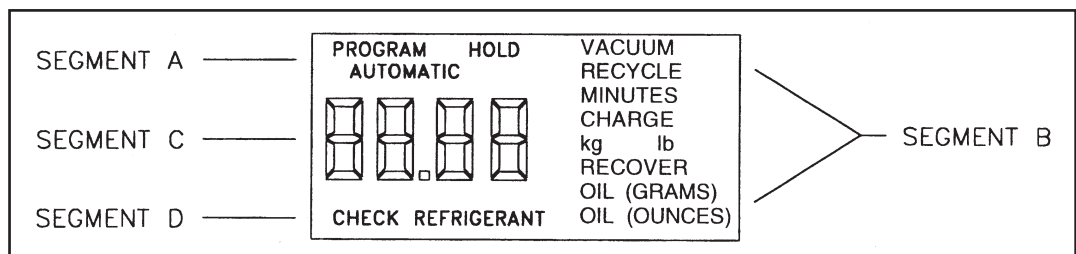

Diagram of Digital Display

Segment A — Indicates in which mode the unit is operating:

PROGRAM — The unit is in the programming mode, which allows you to program vacuum time and refrigerant weight **or** review the existing program.

HOLD — This mode is used to change a refrigerant tank or to interrupt the vacuum/charging/recovery cycles.

AUTOMATIC — Indicates the unit is running in a given cycle and will automatically stop when the cycle is complete. One exception: The recycling process must be stopped by pressing **HOLD/CONT**.

Segment B — Indicates the unit is either evacuating the A/C-R system **OR** recovering, recycling, or recharging refrigerant **OR** that the unit is ready to be programmed for one of the following functions. (Use the chart on the next page as a quick reference for interpreting Segment B messages.)

VACUUM

- With PROGRAM, indicates the unit is ready to be programmed for vacuum.
- With AUTOMATIC, indicates the vacuum pump is running; the number displayed counts down in minutes and seconds, showing the amount of time remaining.
- With HOLD, indicates that **HOLD/CONT** was pressed to interrupt the vacuum cycle.

RECYCLE

- With AUTOMATIC, indicates the unit is recycling refrigerant from the tank.

CHARGE

- With PROGRAM, indicates the unit is ready to be programmed for the amount of refrigerant to be charged into the A/C-R system; on the keypad, enter the charge in pounds and hundredths of a pound or kilograms, depending on the measurement mode selected.
- With AUTOMATIC, indicates the unit is charging refrigerant into the A/C-R system; the number shown on the digital display counts down, showing the remaining amount of refrigerant to be dispensed.
- With HOLD, indicates that **HOLD/CONT** was pressed to interrupt the charging cycle; the number shown on the digital display is the amount of refrigerant remaining to be charged into the A/C-R system; to continue charging, press **HOLD/CONT** again.

RECOVER

- With AUTOMATIC, indicates the unit is recovering refrigerant from the A/C-R system and shows the amount of refrigerant recovered in pounds or kilograms, depending on the measurement mode selected.

OIL (OUNCES) or OIL (GRAMS)

- Lights up as a reminder to drain the oil separator after each job.

Segment C — Shows a number or a coded error message on the digital display that indicates the unit's operating status or any specific problems. See *Troubleshooting* for a list of error codes and messages.

Segment D — Indicates that refrigerant is low — approximately six pounds (or 2.7 kilograms) of refrigerant is left in the tank. Either replace the tank or add refrigerant to the tank.

VACUUM	+	PROGRAM	=	Program unit for vacuum
VACUUM	+	AUTOMATIC	=	Vacuum pump is running
VACUUM	+	HOLD	=	Interrupted vacuum cycle
RECYCLE	+	AUTOMATIC	=	Unit is recycling refrigerant
CHARGE	+	PROGRAM	=	Program unit for charge
CHARGE	+	AUTOMATIC	=	Unit is charging A/C-R system
CHARGE	+	HOLD	=	Interrupted charging cycle
RECOVER	+	AUTOMATIC	=	Unit is recovering refrigerant

Quick Reference Chart for Segment B

USING THE DIAGNOSTIC MODE

The diagnostic mode allows you to run individual components or retrieve stored information. To access the diagnostic mode, press and hold **SHIFT/RESET** and then press **ENTER**. The display will show the message “FUNC.” To exit the diagnostic mode, press **SHIFT/RESET** again.

Some diagnostic functions exit the diagnostic mode when completed, so to continue with more diagnostic functions you must re-enter the diagnostic mode.

Once in the diagnostic mode you can do the following:

Initial Vacuum Mode:

1. Press **1** to enter initial vacuum mode. The display will show the message “VACUUM.” The use of this mode is described in the initial setup instructions in this manual.
2. Press **HOLD/CONT** to stop the pump.

Set Display for Pounds or Kilograms:

1. Press “0” to display the unit of measure currently set (the unit assumes you want to change the setting).
2. Press **ENTER** to toggle between “lb” and “kg”.
3. When the desired setting displays, press **SHIFT/RESET** to save the selection.

Display Total Weight of Recovered Refrigerant:

1. Press “3” to display the total amount of refrigerant recovered by the unit since the last filter-drier change.
2. This counter resets with every filter-drier change.



FUNC

NOTE:

To access the diagnostic mode, press and hold **SHIFT/RESET** and press **ENTER**. The display will show the message “FUNC.” To exit the diagnostic mode, press **SHIFT/RESET** again.

To Test Full Display:

1. Press “5” to see the complete LCD display, which displays only momentarily before returning to Program mode.
2. Press any key to exit.

To Access Scale Function:

1. Press “6” to zero-out the display (regardless of what is on the scale platform). The weight of anything you add to the scale platform will now display.
2. Press **SHIFT/RESET** to exit.

To Display Weight of Refrigerant in Tank:

1. Press “7” to display the weight of refrigerant in the tank.
2. Press any key to exit.

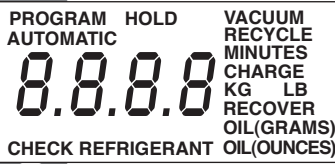

Example of Full Display Test

USING DISPLAY CODES

- 134A** R-134a; indicates R-134a automotive refrigerant requiring 1/2" Acme fittings.
- Add** Add refrigerant to the tank before starting charging procedures.
- CAL** The scale is out of calibration; see *Calibrating the Scale*.
- Check Refrigerant** Tank has six (6) pounds or less of refrigerant; charging will not activate.
- CH-F** Change filter/drier; 200 pounds of refrigerant has been recovered since the last change.
- CH-P** A/C-R system pressure is low; prevents pulling air into the unit from a leaky system.
- CL-c** Clearing complete; indicates the first stage of the clearing process is complete.
- CL-L** The low-side clearing routine is in progress; this occurs when you press **RECOVER** and can last up to four minutes.
- Clr** Self-clearing; if this message is displayed, the unit is in the self-clearing process.
- CON** The vacuum pump will run continuously; press **SHIFT/RESET** to stop.
- CPL** Complete; the current procedure is finished.
- Door** (Flashes) The unit has been cleared, and you can now select a door position. Slide the refrigerant lockout panel (located on the back of the unit, top left corner) to expose the fittings for the selected refrigerant type.
- OIL/drn** (Flashes alternately) Drain; open the oil drain valve to relieve the pressure in the unit.
- FIL** Compressor oil and filter/drier change procedures are being performed.
- FULL** The tank is full; recovery stops automatically.
- HI-P** High pressure; unit pressure is greater than 435 psi.

- OIL** Change vacuum pump oil; it has been 10 hours since the last oil change.
- R12** R-12; indicates R-12 or other refrigerant type requiring $\frac{1}{4}$ " flare fittings.
- SCAL** Scale problem; the scale is broken or disconnected, or the tank has exceeded 75 pounds gross weight.
- U-HI** High pressure to vacuum pump; prevents blowing refrigerant through the vacuum pump. To relieve pressure, perform a recovery process (see *Operating Instructions*).

Replacement Parts

Following is a list of replacement parts and accessories you may need to service or maintain your unit. Tanks, filter-drier, and vacuum pump oil should be purchased through your regular Robinair distributor.

Description	Part No.
50 lb. (23 kg) tank, ¼ in. flare fittings-----	17506
50 lb. (23 kg) tank, ½ in. Acme fittings-----	34750
36" Yellow Hose, Single Quick Seal-----	19293
36" Red Hose, Single Quick Seal-----	68336A
36" Blue Hose, Single Quick Seal w/valve core depressor-----	19339
36" Red Hose, Auto Shut Off-----	19312
36" Blue Hose, Auto Shut Off-----	19311
36" Yellow Hose, Auto Shut Off-----	19310
36" Blue Acme Hose-----	19306
36" Red Acme Hose-----	19307
36" Yellow Acme Hose-----	19313
96" Red Hose, With Ball Valve-----	19296
96" Blue Hose, With Ball Valve-----	19298
96" Red Hose, Auto Shut Off-----	19308
96" Blue Hose, Auto Shut Off-----	19309
96" Red Acme Quick Seal Hose-----	19328
96" Blue Acme Quick Seal Hose-----	19329
Coupler (½ Acme x Service Coupler)-----	16301
Quick Change Filter-----	19776
R-134a Low-side Coupler-----	18190A
R-134a High-side Coupler-----	18191A
Vacuum Pump Oil (1 case of quart bottles)-----	13203

Because of ongoing product improvements, we reserve the right to change design, specifications, and materials without notice.

Flow Diagram

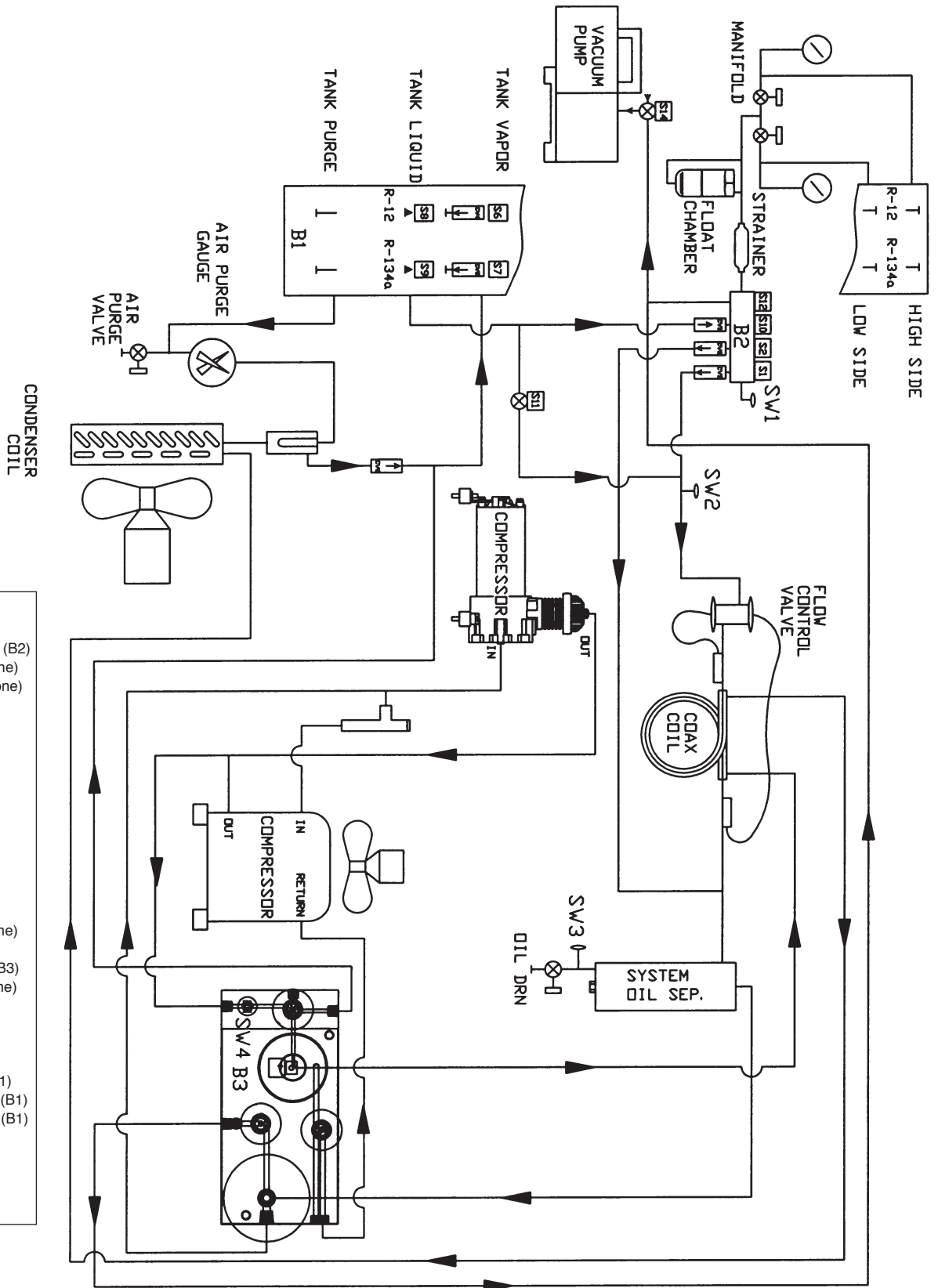

Component List

SWITCHES

- SW1 Vacuum Protection (B2)
 - SW2 Vacuum (stand alone)
 - SW3 Oil Drain (stand alone)
 - SW4 HPCO (B3)
- ### SOLENOIDS
- S1 Recover (B2)
 - S2 Liq/Vap (B2)
 - S3 Self/CLR (B3)
 - S4 Chk Vlv (B3)
 - S5 Oil Return (B3)
 - S6 R12 Vapor (B1)
 - S7 134a Vapor (B1)
 - S8 R12 Liquid (B1)
 - S9 134a Liquid (B1)
 - S10 Charge (B2)
 - S11 Recycle (stand alone)
 - S12 Vacuum (B2)
 - S13 Clearing/Vacuum (B3)
 - S14 Free Air (stand alone)

CHECK VALVES

- C1 Charge (B2)
- C2 Vapor IN (B2)
- C3 Liquid IN (B2)
- C4 R12 Vapor OUT (B1)
- C5 R134a Vapor OUT (B1)
- C6 High-side Clearing (B1)

BLOCKS

- B1 Bulkhead
- B2 Inlet
- B3 Filter/Oil Sep.

Wiring Diagram 17800B

INST0924

ENGLISH

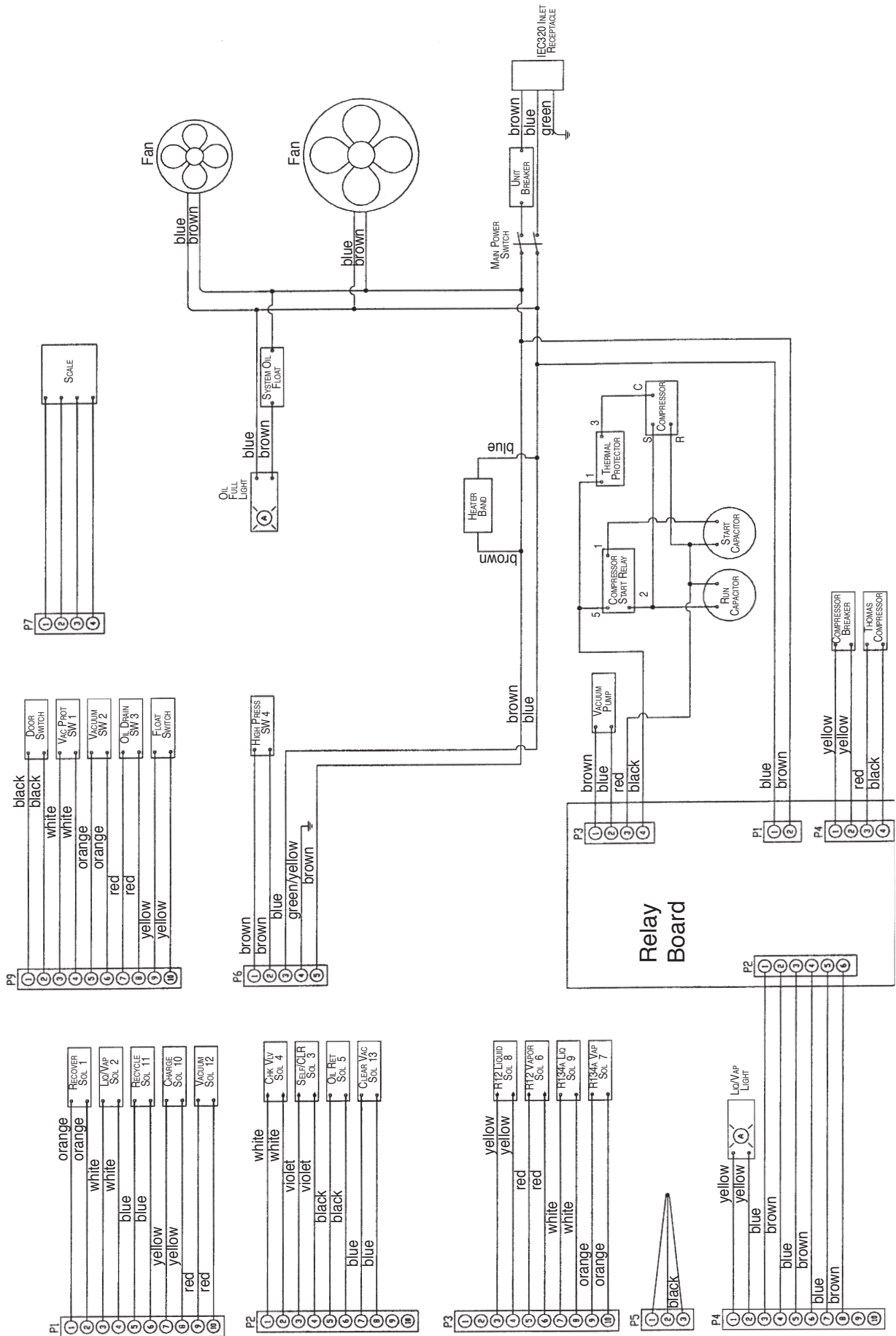

Wiring Diagram 17801B

ENGLISH

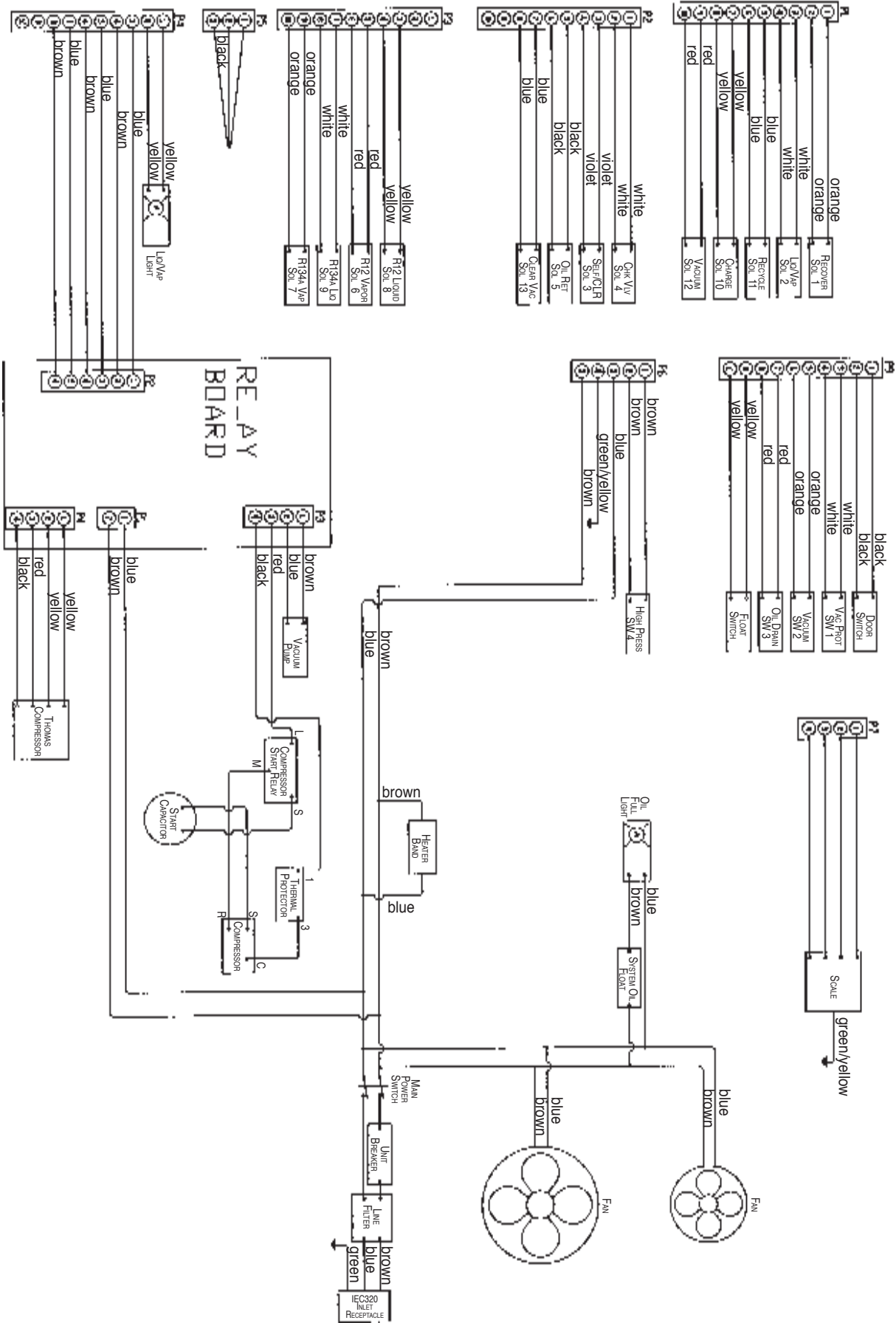

RECOVERY OPERATION

Compressor does not start

Problem: Main power switch is off.

Solution: Turn on switch.

Problem: Power cord is not plugged in, or there is no power at plug.

Solution: Check circuit for power.

Problem: “FULL” message shows on digital display.

Solution: Change tanks (see *Installing a Tank and Pulling A Vacuum*).

Problem: “HI-P” message shows on digital display.

Solution: Verify tanks valves are open and hoses are connected to the tank, **or** Check for air in the tank (recycle tank to purge any air), **or** Check the scale calibration (see *Checking the Scale Accuracy*).

Note: *If the “HI-P” message does not disappear in 20 minutes, the pressure will have to be released manually. Recover the pressure from the HI-P Access Port shown on page 4 in the Diagram of Units Components - Internal View.*

Problem: “CH-F” message on digital display.

Solution: Remove and replace the filter-drier (see *Replacing the Filter-Drier*), and pull a vacuum before continuing.

Runs for a short time but does not complete recovery

Problem: Tank valves are closed.

Solution: Open both valves and verify hoses are connected to the tank.

Problem: Manifold valves are closed.

Solution: Open both valves.

Runs but will not shut off

Problem: Oil drain valve is open.

Solution: Close the oil drain valve.

Problem: There is a leak in the A/C-R system.

Solution: Locate and repair all system leaks.

Problem: Hoses are not connected to the vehicle.

Solution: Check hose connections.

Problem: Oil return solenoid is open.

Solution: Replace the oil return solenoid.

RECYCLING OPERATION

Compressor does not start, or stops prematurely

Problem: Power cord is not plugged in, or there is no power at plug.

Solution: Check circuit for power.

Problem: Tank valves are closed.

Solution: Open both valves, and verify hoses are connected to the tank.

Problem: “CH-F” message on digital display.

Solution: Remove and replace the filter-drier (see *Replacing the Filter-Drier*), and pull a vacuum before continuing.

Refrigerant does not flow

Problem: Refrigerant supply empty or low.

Solution: Add refrigerant to the tank.

Problem: Tank valves are closed.

Solution: Open both valves, and verify hoses are connected to the tank and the unit.

RECHARGING OPERATION

No power when MAIN POWER switch is on — no display showing

Problem: Power cord is not plugged in, or there is no power at plug.

Solution: Check circuit for power.

Problem: The “CHECK REFRIGERANT” message is displayed.

Solution: There are less than 6 pounds of refrigerant in the tank; add refrigerant to the tank.

Audible tone sounds during refrigerant transfer

Problem: Transfer stopped or too slow.

Solution: Close the high-side valve, then start the A/C-R system and pull the remaining refrigerant into the system.

Problem: Refrigerant supply is low or empty.

Solution: Add refrigerant to the tank or change tanks.

Problem: Tank valves are closed.

Solution: Open both valves, and verify hoses are connected to the tank and the unit.

EVACUATION OPERATION

Vacuum pump will not start

Problem: Power cord is not plugged in, or there is no power at plug.

Solution: Check circuit for power.

Problem: The pressure in the A/C-R system is too high.

Solution: Recover the remaining A/C-R system charge.

Problem: “U-HI” message on digital display.

Solution: Recover all refrigerant before pulling a vacuum.

Problem: Vacuum time not entered.

Solution: Program the required time for vacuum.

Vacuum pump runs, but low-side gauge does not register an appropriate vacuum

Problem: Low-side valve is closed.

Solution: Open the low-side valve.

Problem: Pump oil is contaminated.

Solution: Flush and change the vacuum pump oil.

Problem: Hose connection is loose, or manifold is leaking.

Solution: Check connections.

CLEARING OPERATION

“CLR” displays on screen

Problem: Pressing **HOLD/CONT** does not clear the display.

Solution: Slide the lockout panel on the back of the unit to expose the fittings for the correct refrigerant type. Connect the appropriate hoses, and perform a clearing procedure (see Step 12 in *Setup Instructions*).

Robinair Limited Warranty Statement

Rev. November 1, 2005

This product is warranted to be free from defects in workmanship, materials, and components for a period of one year from date of purchase. All parts and labor required to repair defective products covered under the warranty will be at no charge. The following restrictions apply:

1. The limited warranty applies to the original purchaser only.
2. The warranty applies to the product in normal usage situations only, as described in the Operating Manual. The product must be serviced and maintained as specified.
3. If the product fails, it will be repaired or replaced at the option of the manufacturer.
4. Transportation charges for warranty service will be reimbursed by the factory upon verification of the warranty claim and submission of a freight bill for normal ground service. Approval from the manufacturer must be obtained prior to shipping to an authorized service center.
5. Warranty service claims are subject to authorized inspection for product defect(s).
6. The manufacturer shall not be responsible for any additional costs associated with a product failure including, but not limited to, loss of work time, loss of refrigerant, cross-contamination of refrigerant, and unauthorized shipping and/or labor charges.
7. All warranty service claims must be made within the specified warranty period. Proof-of-purchase date must be supplied to the manufacturer.
8. Use of recovery/recycling equipment with unauthorized refrigerants or sealants will void warranty.
 - Authorized refrigerants are listed on the equipment or are available through the Technical Service Department.
 - The manufacturer prohibits the use of the recovery/recycling equipment on air conditioning (A/C) systems containing leak sealants, either of a seal-swelling or aerobic nature.

This Limited Warranty does NOT apply if:

- The product, or product part, is broken by accident.
- The product is misused, tampered with, or modified.
- The product is used for recovering or recycling any substance other than the specified refrigerant type. This includes, but is not limited to, materials and chemicals used to seal leaks in A/C systems.

A/C-R System Evacuation	14	Operating Guidelines	31
Adding Refrigerant to the Tank	18	Keypad Functions	32
Calibrating the Scale	27	Using the Control Panel	31
Circuit Calibration, UL	28	Using the Diagnostic Mode	35
Changing Refrigerant Types	12	Using the Digital Display	32
Changing the Filter-Drier	24	Using Display Codes	37
Changing the Temperature Scale	30	Operating Instructions	10
Changing the Vacuum Pump Oil	23	A/C-R System Evacuation	14
Charging Procedures	16	Adding Refrigerant to the Tank	18
Checking for Leaks	30	Changing Refrigerant Types	12
Confirming the Scale Checklist	26	Charging Procedures	16
Control Panel, Diagram	5, 10, 31	Correcting An Incomplete Transfer	17
Control Panel, Using	31	Recovery Procedures	10
Components, Diagram of Unit's	4, 5, 6, 12	Recycling Procedures	15
Correcting an Incomplete Transfer	17	Overview	20
Diagnostic Mode, Using	35	Charging	22
Digital Display, Diagram	32	Evacuation	21
Digital Display, Using	32	Recovery	20
Display Codes, Using	37	Recycling	21
Evacuation, A/C-R System	14	Recycling Procedures	15
Filter-Drier, Diagram	25	Recovery Procedures	10
Flow Diagram	40	Replacement Parts	39
General Operating Guidelines	3	Scale, Calibrating the	27
Glossary of Terms	2	Scale Checklist, Confirming	26
Hose Connections, Lockout Box	7	Setup Instructions	4
Introduction	2	Troubleshooting	43
Keypad, Diagram	32	Clearing Operation	46
Keypad Functions	32	Evacuation Operation	46
Leaks, Checking	30	Recharging Operation	45
Limited Warranty	47	Recovery Operation	43
Maintenance Procedures	23	Recycling Operation	44
Calibrating the Scale	27	UL Circuit Calibration	28
Changing the Filter-Drier	24	Unit's Components, Diagram	4, 5, 6, 12
Changing the Temperature Scale	30	Using the Control Panel	31
Changing the Vacuum Pump Oil	23	Using the Diagnostic Mode	35
Checking for Leaks	30	Using the Digital Display	32
Correct Weight Verification	26	Using Display Codes	37
		Vacuum Pump Components, Diagram	8, 23
		Warranty, Limited	47
		Wiring Diagram	41, 42

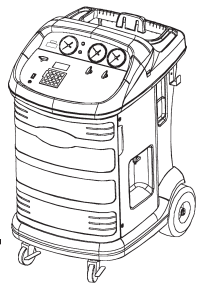

**Conversion
Table
Tabla de
conversión
Table de
Conversion**

OZ. onzas	LBS. libras
0.5	0.03
1.0	0.06
1.5	0.09
2.0	0.13
2.5	0.16
3.0	0.19
3.5	0.22
4.0	0.25
4.5	0.28
5.0	0.31
5.5	0.34
6.0	0.38
6.5	0.41
7.0	0.44
7.5	0.47
8.0	0.50
8.5	0.53
9.0	0.56
9.5	0.59
10.0	0.63
10.5	0.66
11.0	0.69
11.5	0.72
12.0	0.75
12.5	0.78
13.0	0.81
13.5	0.84
14.0	0.88
14.5	0.91
15.0	0.94
15.5	0.97
16.0	1 lb.

**Visit our web site at www.robinair.com or call our toll-free
Technical Support Line at 800-822-5561
in the continental U.S. or Canada.**

In all other locations, contact your local distributor. To help us serve you better, please be prepared to provide the model number, serial number, and date of purchase of your unit. To validate your warranty, complete the warranty card attached to the unit, and return it within ten days from date of purchase.

NATIONWIDE NETWORK OF AUTHORIZED SERVICE CENTERS

If your unit needs repair or replacement parts, contact the service center in your area. For help in locating a service center, call the toll-free technical support line or visit www.robinair.com.

**Visite nuestro sitio web en www.robinair.com o llame sin costo a
la línea de Asistencia técnica al 800-822-5561
en EE.UU. continental o Canadá.**

En todas las demás ubicaciones, comuníquese con su distribuidor local. Para ayudarnos a servirle mejor, tenga a mano el número de modelo, número de serie y fecha de compra de su unidad. Para validar la garantía, complete la tarjeta de garantía anexa a su unidad y devuélvala dentro de los diez días siguientes a la fecha de compra.

RED NACIONAL DE CENTROS DE SERVICIO AUTORIZADOS

Si su unidad necesita reparaciones o partes de reemplazo, comuníquese con el centro de servicio de su área. Para obtener ayuda para ubicar un centro de servicio, llame sin costo a la línea de asistencia técnica o visite www.robinair.com.

**Visitez notre site Web à www.robinair.com ou appelez sans frais
le soutien technique au 800-822-5561
sur le territoire continental des États-Unis ou au Canada.**

Pour tout autre endroit, communiquez avec votre distributeur local. Afin de nous aider à mieux vous servir, soyez prêt à nous donner le numéro de modèle, le numéro de série et la date de l'achat de votre unité. Afin de valider votre garantie, remplissez la carte de garantie jointe à votre système et retournez-la dans les dix jours de la date d'achat.

RÉSEAU NATIONAL DES CENTRES DE SERVICE AUTORISÉS

Si votre unité a besoin d'être réparée ou à besoin de pièces de remplacement, communiquez avec le centre de service de votre région. Pour vous aider à localiser un centre de service, appelez sans frais la ligne de soutien technique ou visitez le www.robinair.com.

The Robinair 17800B/17801B unit is designed to meet all applicable agency certifications, including Underwriter's Laboratories, Inc., SAE Standards, and CUL. Certain state and local jurisdictions dictate that using this equipment to sell refrigerant by weight may not be permitted. We recommend charging for any A/C service by the job performed. This weight scale provides a means of metering the amount of refrigerant needed for optimum A/C system performance as recommended by OEM manufacturers

La unidad Robinair 17800B/17801B está diseñada para cumplir con todas las certificaciones de agencia aplicables, incluyendo Underwriter's Laboratories, Inc., Estándares SAE y CUL. Ciertas jurisdicciones estatales y locales prescriben que el uso de este equipo para vender refrigerante por peso es posible que no sea permitido. Recomendamos que se cobre el trabajo realizado por dar servicio al aire acondicionado. Esta escala de peso proporciona un medio para medir la cantidad de refrigerante que se necesita para el rendimiento óptimo del sistema de aire acondicionado, tal como lo recomiendan los fabricantes OEM.

Le modèle 17800B/17801B a été conçu pour répondre aux certifications applicables de la Underwriter's Laboratories, Inc., aux normes SAE et CUL. Certains endroits dictent l'utilisation de cet équipement et il peut arriver que la vente de fluide frigorigène en fonction du poids puisse être interdite. Nous vous recommandons de facturer les services de climatisation en fonction du travail effectué. Ce poids de tarification permet de calculer la quantité de fluide frigorigène nécessaire pour un rendement optimum de la climatisation, tel qu'il est recommandé par les fabricants de l'équipement d'origine.

Due to ongoing product improvements, we reserve the right to change design, specifications, and materials without notice.

Debido a las constantes mejoras del producto, nos reservamos el derecho de cambiar diseño, especificaciones y materiales sin aviso.

En raison des améliorations constantes apportées à nos produits, nous nous réservons le droit de changer de concept, de spécifications et de matériaux sans préavis.

ROBINAIR®

655 Eisenhower Drive
Owatonna, MN 55060 USA
Tech Services: 1-800-822-5561
Fax: 1-866-259-1241
Customer Service: 1-800-533-6127
Fax: 1-800-322-2890
Web site: www.robinair.com